

SECTION WCS

WARNING CHIME SYSTEM

A
B
C
D
E
F
G
H
I
J
K
L
M
O
P

CONTENTS

BASIC INSPECTION	3	PARKING BRAKE RELEASE WARNING CHIME : System Description	10
DIAGNOSIS AND REPAIR WORKFLOW	3	PARKING BRAKE RELEASE WARNING CHIME : Component Parts Location	11
Work Flow	3	PARKING BRAKE RELEASE WARNING CHIME : Component Description	11
FUNCTION DIAGNOSIS	4	DIAGNOSIS SYSTEM (METER)	13
WARNING CHIME SYSTEM	4	Diagnosis Description	13
WARNING CHIME SYSTEM	4	CONSULT-III Function (METER/M&A)	13
WARNING CHIME SYSTEM : System Diagram	4	DIAGNOSIS SYSTEM (BCM)	16
WARNING CHIME SYSTEM : System Description	4	BUZZER	16
WARNING CHIME SYSTEM : Component Parts Location	5	BUZZER : CONSULT-III Function (BCM-BUZZ- ER)	16
WARNING CHIME SYSTEM : Component De- scription	5	COMPONENT DIAGNOSIS	17
LIGHT REMINDER WARNING CHIME	6	POWER SUPPLY AND GROUND CIRCUIT	17
LIGHT REMINDER WARNING CHIME : System Diagram	6	COMBINATION METER	17
LIGHT REMINDER WARNING CHIME : System Description	6	COMBINATION METER : Diagnosis Procedure	17
LIGHT REMINDER WARNING CHIME : Compo- nent Parts Location	7	BCM (BODY CONTROL MODULE)	17
LIGHT REMINDER WARNING CHIME : Compo- nent Description	7	BCM (BODY CONTROL MODULE) : Diagnosis Procedure	18
SEAT BELT WARNING CHIME	8	METER BUZZER CIRCUIT	19
SEAT BELT WARNING CHIME : System Diagram	8	Description	19
SEAT BELT WARNING CHIME : System Descrip- tion	8	Component Function Check	19
SEAT BELT WARNING CHIME : Component Parts Location	9	Diagnosis Procedure	19
SEAT BELT WARNING CHIME : Component De- scription	9	SEAT BELT BUCKLE SWITCH SIGNAL CIR- CUIT	20
PARKING BRAKE RELEASE WARNING CHIME	10	Description	20
PARKING BRAKE RELEASE WARNING CHIME : System Diagram	10	Component Function Check	20
		Diagnosis Procedure	20
		Component Inspection	21
		WARNING CHIME SYSTEM	22
		Wiring Diagram	22

WCS

ECU DIAGNOSIS	28	Description	90
		Diagnosis Procedure	90
COMBINATION METER	28	THE LIGHT REMINDER WARNING DOES NOT SOUND	91
Reference Value	28	Description	91
Wiring Diagram	32	Diagnosis Procedure	91
Fail Safe	51	THE SEAT BELT WARNING CONTINUES SOUNDING, OR DOES NOT SOUND	92
DTC Index	52	Description	92
BCM (BODY CONTROL MODULE)	53	Diagnosis Procedure	92
Reference Value	53	PRECAUTION	93
Terminal Layout	58	PRECAUTIONS	93
Physical Values	58	Precaution for Supplemental Restraint System (SRS) "AIR BAG" and "SEAT BELT PRE-TENSIONER"	93
Wiring Diagram	76	Precautions Necessary for Steering Wheel Rotation after Battery Disconnect (Early Production, With Electronic Steering Column Lock)	93
Fail Safe	84		
DTC Inspection Priority Chart	86		
DTC Index	88		
SYMPTOM DIAGNOSIS	90		
THE PARKING BRAKE RELEASE WARNING CONTINUES SOUNDING, OR DOES NOT SOUND	90		

DIAGNOSIS AND REPAIR WORKFLOW

< BASIC INSPECTION >

BASIC INSPECTION

DIAGNOSIS AND REPAIR WORKFLOW

Work Flow

INFOID:000000005459935

DETAILED FLOW

1.OBTAIN INFORMATION ABOUT SYMPTOM

Interview the customer to obtain as much information as possible about the conditions and environment under which the malfunction occurred.

>> GO TO 2

2.CHECK SYMPTOM

- Check the symptom based on the information obtained from the customer.
- Check to see if any other malfunctions are present.

>> GO TO 3

3.CHECK CONSULT-III SELF-DIAGNOSIS RESULTS

Connect CONSULT-III and perform "SELF-DIAGNOSIS". Refer to [MWI-29. "CONSULT-III Function \(METER/M&A\)"](#).

Are self-diagnosis results normal?

YES >> GO TO 4

NO >> Repair or replace the malfunctioning parts, GO TO 5

4.NARROW DOWN MALFUNCTIONING PARTS THROUGH SYMPTOM DIAGNOSIS

Perform symptom diagnosis and repair or replace the identified malfunctioning parts.

>> GO TO 5

5.FINAL CHECK

Check that the warning buzzer in the combination meter operates normally.

Does it operate normally?

YES >> Inspection End.

NO >> GO TO 1

A
B
C
D
E
F
G
H
I
J
K
L
M
O
P

WCS

WARNING CHIME SYSTEM

< FUNCTION DIAGNOSIS >

FUNCTION DIAGNOSIS

WARNING CHIME SYSTEM

WARNING CHIME SYSTEM

WARNING CHIME SYSTEM : System Diagram

INFOID:000000005459936

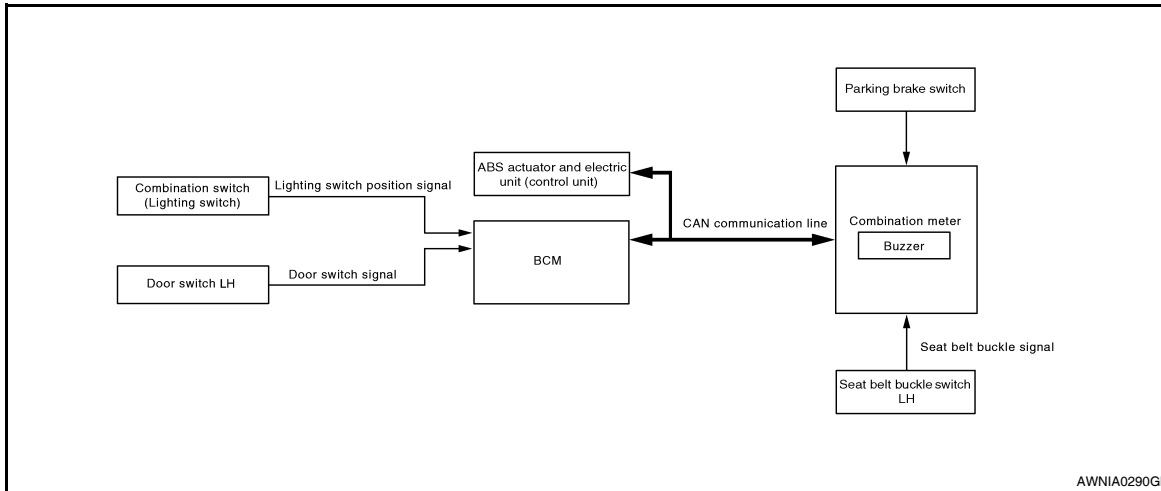

WARNING CHIME SYSTEM : System Description

INFOID:000000005459937

COMBINATION METER

- The buzzer (1) for warning chime system is installed in the combination meter.
- The buzzer sounds when the combination meter receives a buzzer output signal from each unit.

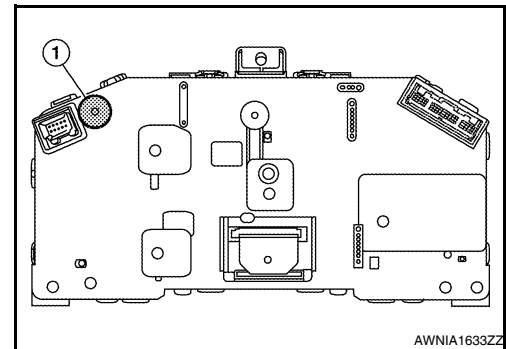

BCM

BCM receives signals from various units and transmits a buzzer output signal to the combination meter with CAN communication line if it judges that the warning buzzer should be activated.

BCM warning function list

Warning functions	Signal name
Light reminder warning chime	<ul style="list-style-type: none"> • Lighting switch position signal • Door switch signal
Seat belt warning chime	Seat belt buckle switch signal

WARNING CHIME SYSTEM

< FUNCTION DIAGNOSIS >

WARNING CHIME SYSTEM : Component Parts Location

INFOID:000000005459938

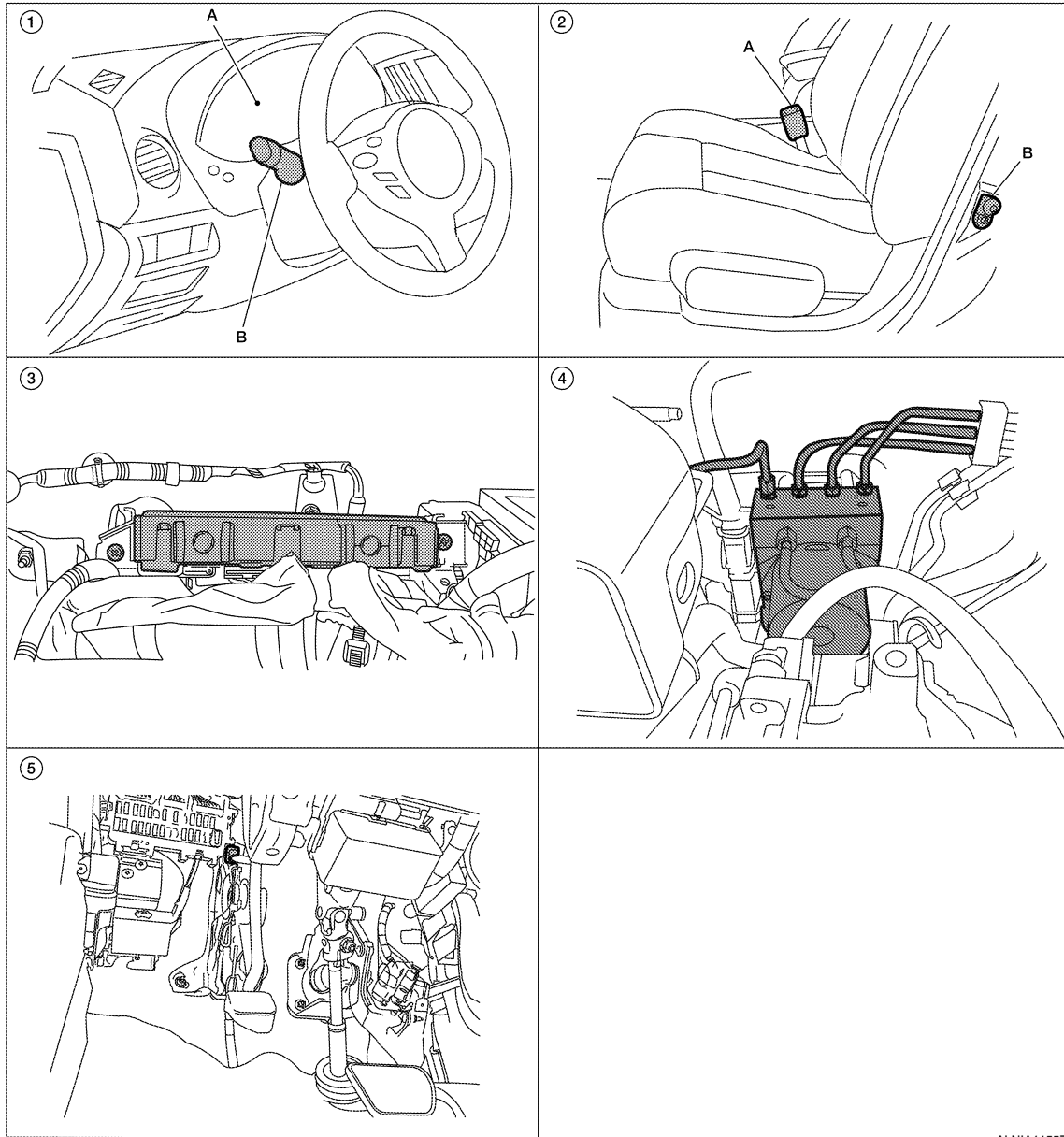

- | | | |
|--|--|---|
| <p>1. A. Combination meter M24
B. Combination switch (lighting switch) M28</p> | <p>2. A. Seat belt buckle switch LH B202
B. Door switch LH B8</p> | <p>3. BCM M16, M17, M18, M19 (view with instrument panel removed)</p> |
| <p>4. ABS actuator and electric unit (control unit) E26</p> | <p>5. Parking brake switch E35 [view with instrument panel lower cover (LH) removed]</p> | |

ALNIA1155ZZ

WARNING CHIME SYSTEM : Component Description

INFOID:000000005459939

Unit	Description
Combination meter	<ul style="list-style-type: none"> Judges whether the parking brake is released using the vehicle speed signal and the parking brake switch signal, and sounds the buzzer if necessary. Receives the seat belt buckle switch signal from the seat belt buckle switch and transmits it to BCM with CAN communication line. Receives a buzzer output signal from BCM with CAN communication line.
BCM	Transmits signals provided by various units to the combination meter with CAN communication line.

WARNING CHIME SYSTEM

< FUNCTION DIAGNOSIS >

Unit	Description
ABS actuator and electric unit (control unit)	Transmits the vehicle speed signal to combination meter with CAN communication line.
Seat belt buckle switch LH	Transmits a seat belt buckle switch signal to the combination meter.
Combination switch (Lighting switch)	Transmits the lighting switch position signal to BCM.
Door switch LH	Transmits the door switch signal to BCM.
Parking brake switch	Transmits parking brake signal to combination meter.

LIGHT REMINDER WARNING CHIME

LIGHT REMINDER WARNING CHIME : System Diagram

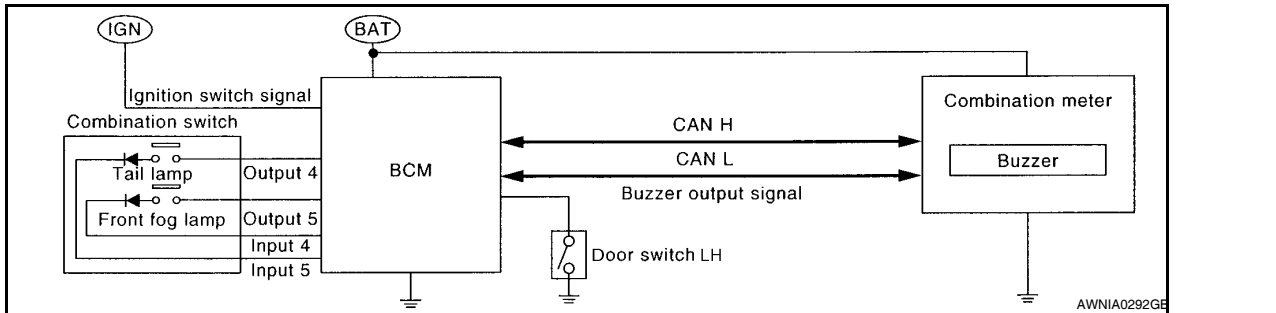

LIGHT REMINDER WARNING CHIME : System Description

INFOID:000000005459941

DESCRIPTION

With ignition switch in OFF or ACC position, driver door open, and lighting switch in 1ST or 2ND position, the light warning chime will sound.

- BCM detects ignition switch in OFF or ACC position, door switch LH ON, and lighting switch in 1ST or 2ND position and then transmits buzzer output signal (light reminder warning chime) to combination meter with CAN communication line.
- When combination meter receives buzzer output signal (light reminder warning chime), it sounds the buzzer.

WARNING OPERATION CONDITIONS

If all of the following conditions are fulfilled

- Lighting switch is at 1st or 2nd position
- Ignition switch is at OFF or ACC
- Door switch LH is ON

WARNING CANCEL CONDITIONS

Warning is canceled if any of the following conditions is fulfilled.

- Lighting switch OFF
- Ignition switch ON
- Door switch LH is OFF

WARNING CHIME SYSTEM

< FUNCTION DIAGNOSIS >

LIGHT REMINDER WARNING CHIME : Component Parts Location

INFOID:000000005459942

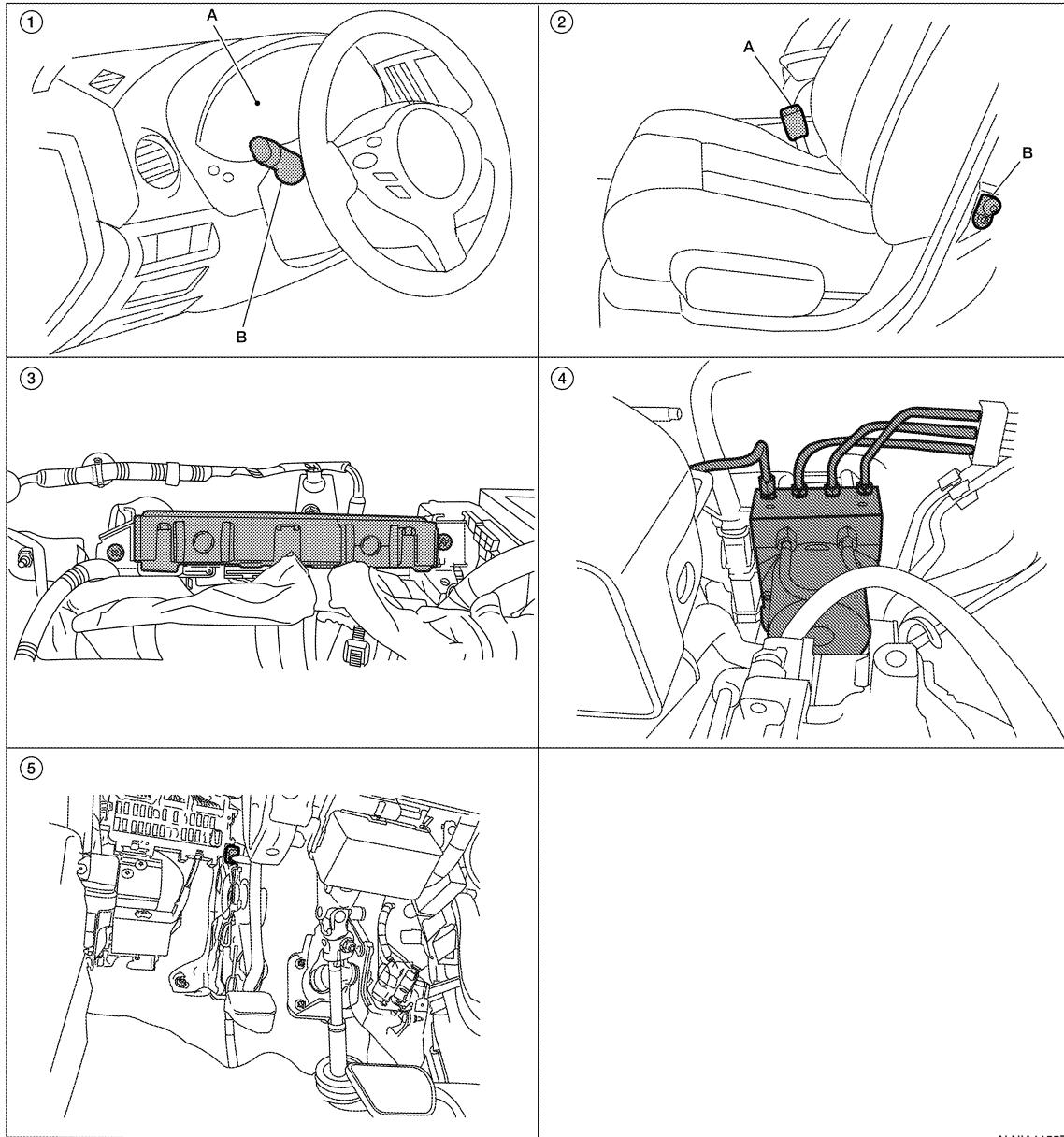

- | | | |
|--|--|---|
| <p>1. A. Combination meter M24
B. Combination switch (lighting switch) M28</p> <p>4. ABS actuator and electric unit (control unit) E26</p> | <p>2. A. Seat belt buckle switch LH B202
B. Door switch LH B8</p> <p>5. Parking brake switch E35 [view with instrument panel lower cover (LH) removed]</p> | <p>3. BCM M16, M17, M18, M19 (view with instrument panel removed)</p> |
|--|--|---|

ALNIA1155ZZ

LIGHT REMINDER WARNING CHIME : Component Description

INFOID:000000005459943

Unit	Description
Combination meter	Receives a buzzer output signal from BCM via CAN communication line and sounds the buzzer.
BCM	Judges the light warning conditions from the signals provided by various switches and transmits a buzzer output signal to the combination meter via CAN communication line if necessary.
Combination switch (Lighting switch)	Transmits the lighting switch position signal to BCM.
Door switch LH	Transmits the door switch signal to BCM.

A
B
C
D
E
F
G
H
I
J
K
L
M
N
O
P

WCS

WARNING CHIME SYSTEM

< FUNCTION DIAGNOSIS >

SEAT BELT WARNING CHIME

SEAT BELT WARNING CHIME : System Diagram

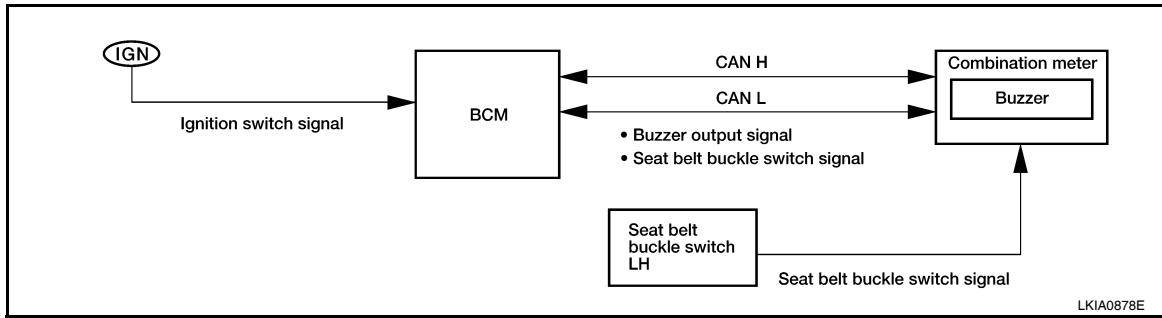

SEAT BELT WARNING CHIME : System Description

INFOID:000000005459945

DESCRIPTION

With ignition switch turned ON and driver seat belt unfastened, seat belt warning chime will sound for approximately 6 seconds.

- BCM receives seat belt buckle switch signal from combination meter with CAN communication line.
- BCM detects ignition switch turned ON and seat belt buckle switch LH ON and then transmits buzzer output signal (seat belt warning chime) to combination meter with CAN communication line.
- When combination meter receives buzzer output signal (seat belt warning chime), it sounds the buzzer.

WARNING OPERATION CONDITIONS

If all of the following conditions are fulfilled

- Ignition switch OFF→ON
- Seat buckle switch LH is ON (driver seat belt not fastened)

WARNING CANCEL CONDITIONS

Cancels the warning if any of the following conditions is fulfilled.

- Ignition switch OFF
- Seat buckle switch LH is OFF (driver seat belt fastened)
- 90 seconds have passed since the start of the warning

WARNING CHIME SYSTEM

< FUNCTION DIAGNOSIS >

SEAT BELT WARNING CHIME : Component Parts Location

INFOID:000000005459946

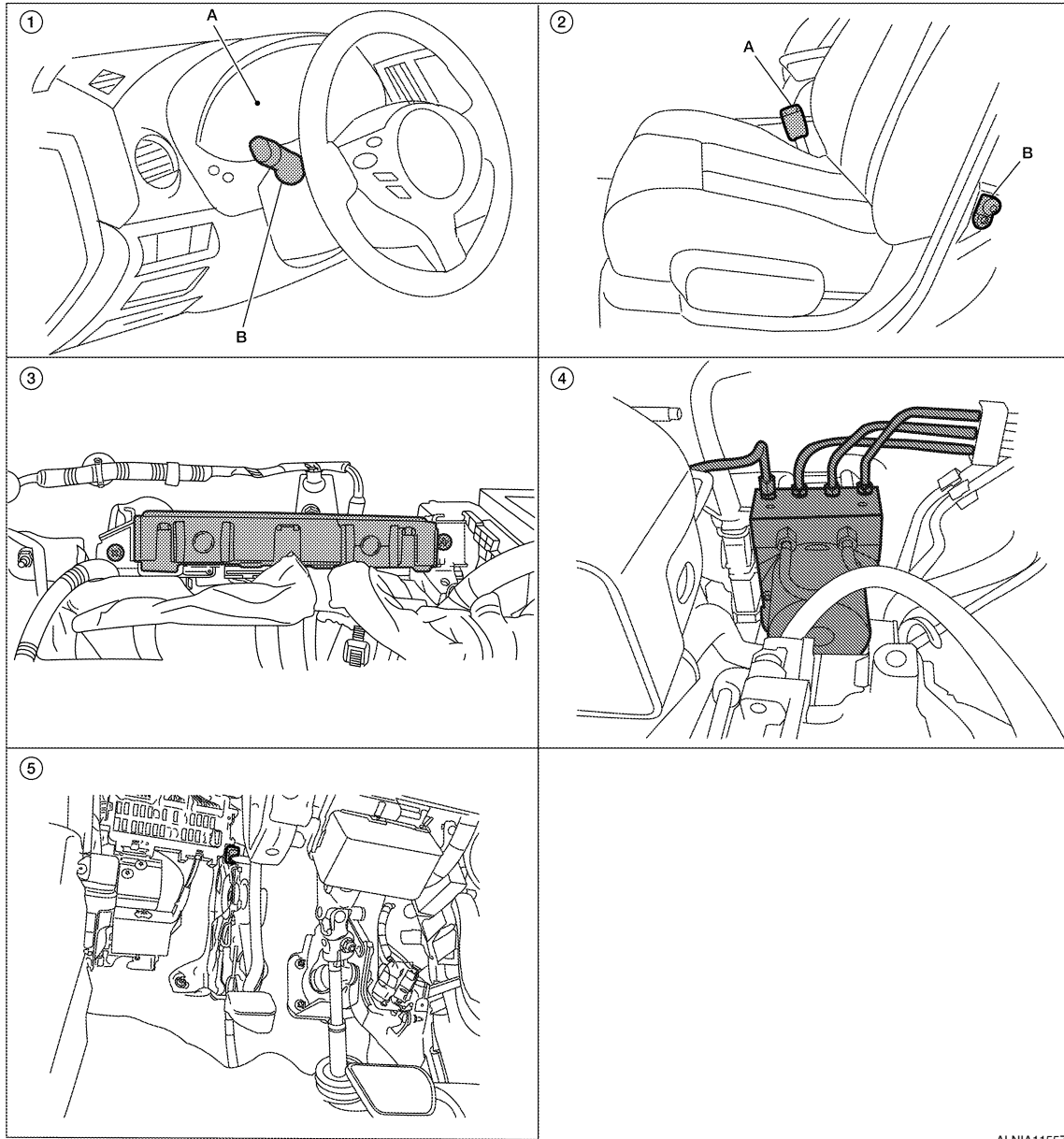

- | | | |
|--|--|---|
| <p>1. A. Combination meter M24
B. Combination switch (lighting switch) M28</p> | <p>2. A. Seat belt buckle switch LH B202
B. Door switch LH B8</p> | <p>3. BCM M16, M17, M18, M19 (view with instrument panel removed)</p> |
| <p>4. ABS actuator and electric unit (control unit) E26</p> | <p>5. Parking brake switch E35 [view with instrument panel lower cover (LH) removed]</p> | |

ALNIA1155ZZ

SEAT BELT WARNING CHIME : Component Description

INFOID:000000005459947

Unit	Description
Combination meter	<ul style="list-style-type: none"> • Receives the seat belt buckle switch signal from the seat belt buckle switch and transmits it to BCM via CAN communication line. • Receives a buzzer output signal from BCM via CAN communication line and sounds the buzzer.
BCM	Judges the seat belt warning condition from the seat belt buckle switch signal received from the combination meter and transmits a buzzer output signal to the combination meter via CAN communication line if necessary.
Seat belt buckle switch LH	Transmits seat belt buckle switch signal to combination meter.

A
B
C
D
E
F
G
H
I
J
K
L
M
N
O
P

WCS

WARNING CHIME SYSTEM

< FUNCTION DIAGNOSIS >

PARKING BRAKE RELEASE WARNING CHIME

PARKING BRAKE RELEASE WARNING CHIME : System Diagram

INFOID:000000005459948

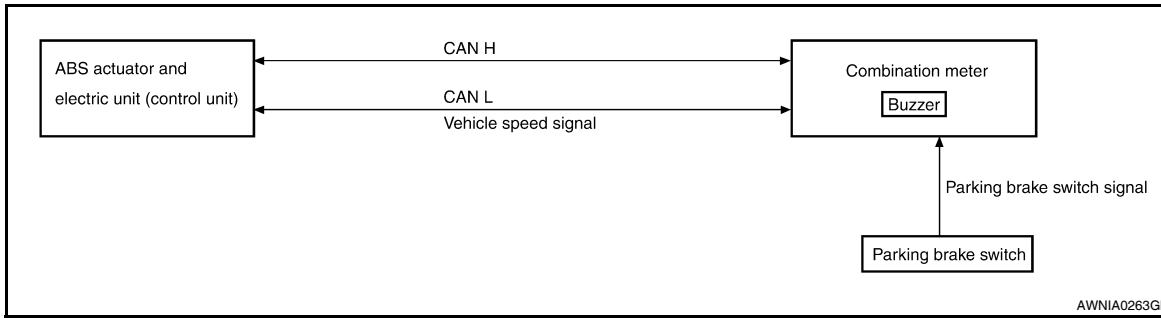

AWNIA0263GE

PARKING BRAKE RELEASE WARNING CHIME : System Description

INFOID:000000005459949

DESCRIPTION

- The combination meter receives the vehicle speed signal from the ABS actuator and electric unit (control unit) via CAN communication line.
- The combination meter judges whether the parking brake is released using the parking brake switch signal from the parking brake switch, and sounds the warning buzzer if necessary.

WARNING OPERATION CONDITIONS

If all of the following conditions are fulfilled

- Vehicle speed is approximately 7 km/h (4.3 MPH) or higher
- Parking brake switch ON

WARNING CANCEL CONDITIONS

Warning is canceled if any of the following conditions is fulfilled.

- Vehicle speed is approximately 3 km/h (1.9 MPH) or less
- Parking brake switch OFF

WARNING CHIME SYSTEM

< FUNCTION DIAGNOSIS >

PARKING BRAKE RELEASE WARNING CHIME : Component Parts Location

INFOID:000000005459950

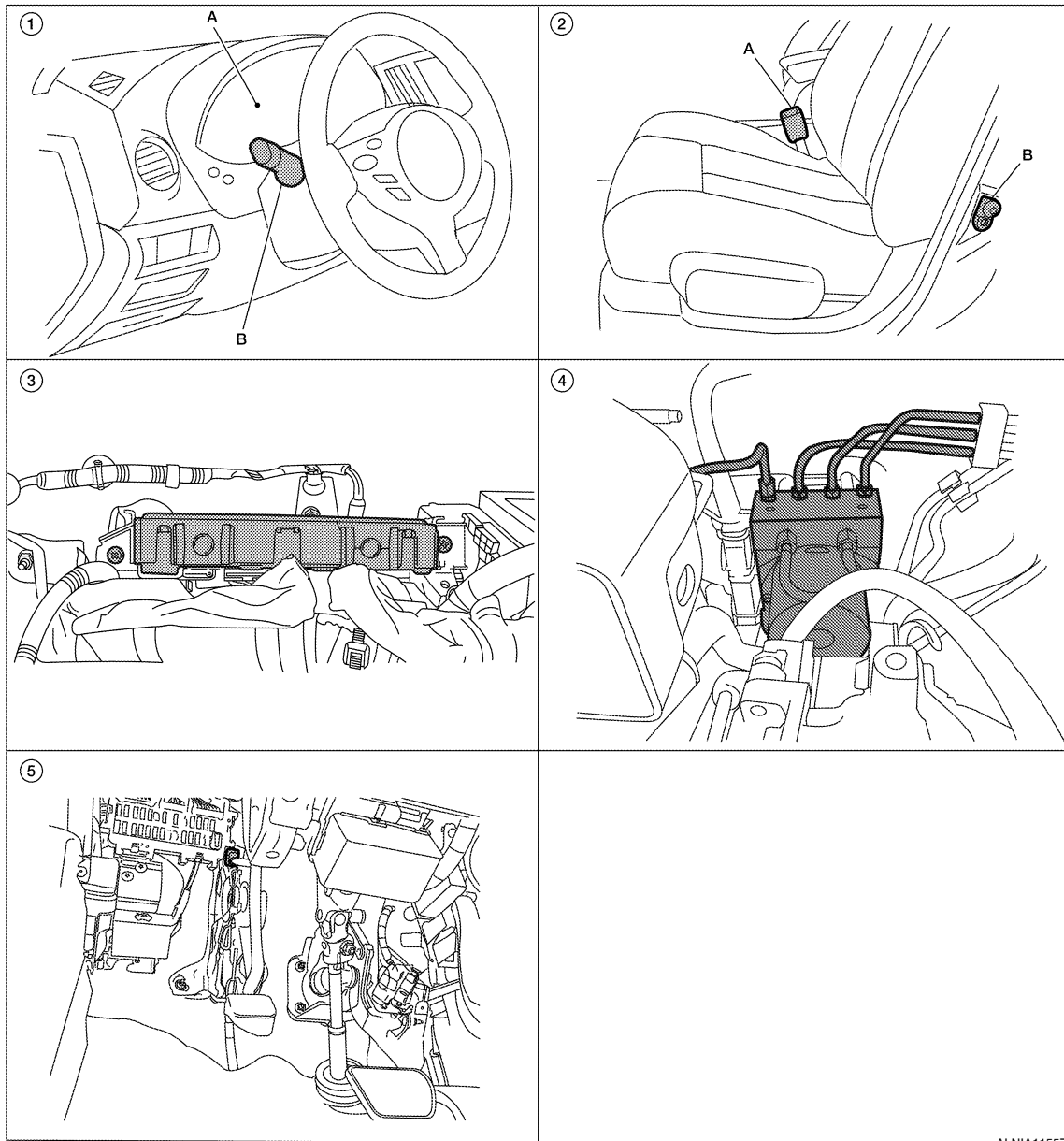

- | | | |
|--|--|---|
| <p>1. A. Combination meter M24
B. Combination switch (lighting switch) M28</p> <p>4. ABS actuator and electric unit (control unit) E26</p> | <p>2. A. Seat belt buckle switch LH B202
B. Door switch LH B8</p> <p>5. Parking brake switch E35 [view with instrument panel lower cover (LH) removed]</p> | <p>3. BCM M16, M17, M18, M19 (view with instrument panel removed)</p> |
|--|--|---|

ALNIA1155ZZ

PARKING BRAKE RELEASE WARNING CHIME : Component Description

INFOID:000000005459951

Unit	Description
Combination meter	<ul style="list-style-type: none"> Judges whether the parking brake is released using the parking brake switch signal from the parking brake switch, and sounds the buzzer if necessary. Receives a vehicle speed signal from ABS actuator and electric unit (control unit) via CAN communication line.

A
B
C
D
E
F
G
H
I
J
K
L
M
O
P

WCS

WARNING CHIME SYSTEM

< FUNCTION DIAGNOSIS >

Unit	Description
ABS actuator and electric unit (control unit)	Transmits the vehicle speed signal to combination meter via CAN communication line.
Parking brake switch	Transmits parking brake switch signal to the combination meter.

DIAGNOSIS SYSTEM (METER)

< FUNCTION DIAGNOSIS >

DIAGNOSIS SYSTEM (METER)

Diagnosis Description

INFOID:000000005511892

SELF-DIAGNOSIS MODE

- Odo/trip meter and information display segment operation can be checked in self-diagnosis mode.
- Meters/gauges can be checked in self-diagnosis mode.

OPERATION PROCEDURE

1. Turn the ignition switch OFF.
2. While pushing the odo/trip meter switch, turn the ignition switch ON again.
3. Push the odo/trip meter switch at least 3 times within 7 seconds after the ignition switch is turned ON.
4. The unified meter control unit is turned to self-diagnosis mode.
 - All the segments on the odo/trip meter illuminate.

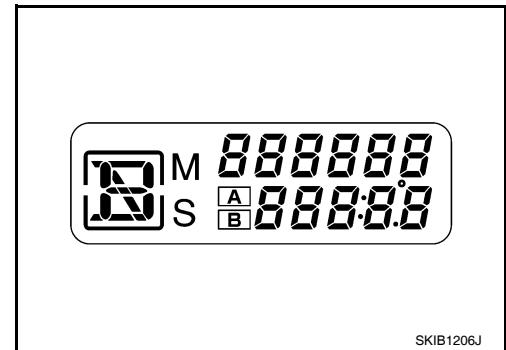

- Dots in all segments of information display LCD (1) flash alternately.

NOTE:

If any of the segments are not displayed, replace the combination meter. Refer to [MWI-140, "Removal and Installation"](#).

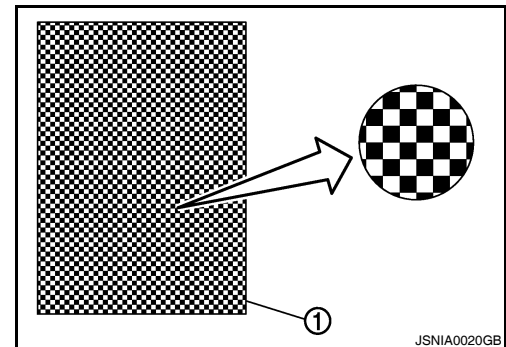

5. Push the odo/trip meter switch. Each meter/gauge should indicate as shown in the figure.

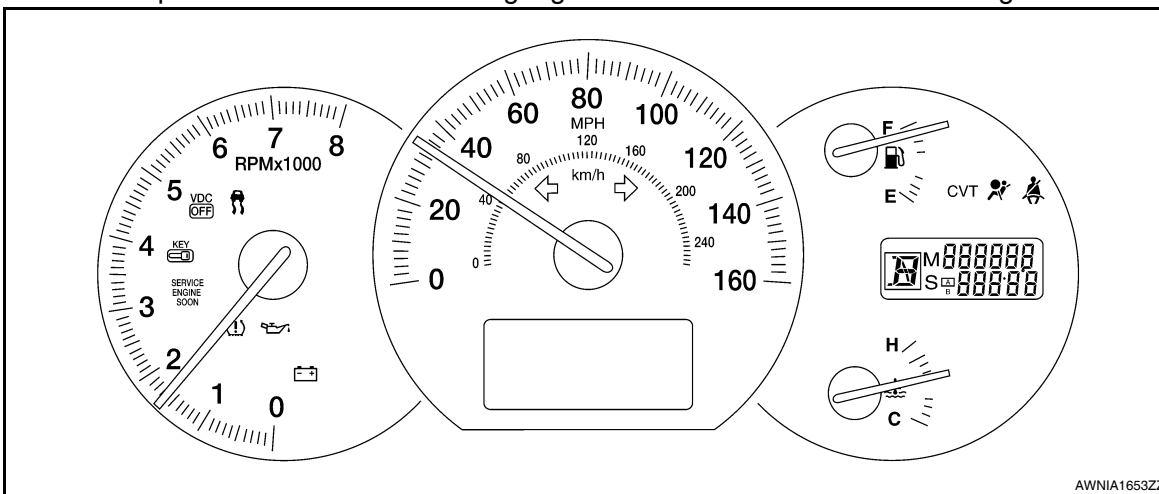

CONSULT-III Function (METER/M&A)

INFOID:000000005511893

CONSULT-III can display each diagnostic item using the diagnostic test modes shown following.

A
B
C
D
E
F
G
H
I
J
K
L
M
O
P

WCS

DIAGNOSIS SYSTEM (METER)

< FUNCTION DIAGNOSIS >

METER/M&A diagnosis mode	Description
SELF-DIAG RESULTS	Displays combination meter self-diagnosis results.
DATA MONITOR	Displays combination meter input/output data in real time.
CAN DIAG SUPPORT MNTR	The result of transmit/receive diagnosis of CAN communication can be read.

SELF-DIAG RESULTS

Display Item List

Refer to [WCS-52. "DTC Index"](#).

DATA MONITOR

Display Item List

X: Applicable

Display item [Unit]	MAIN SIGNALS	SELECTION FROM MENU	Description
SPEED METER [km/h] or [mph]	X	X	Displays the value of vehicle speed signal.
SPEED OUTPUT [km/h] or [mph]	X	X	Displays the value of vehicle speed signal, which is transmitted to each unit with CAN communication.
ODO OUTPUT		X	Displays the value, which is calculated by vehicle speed signal.
TACHO METER [rpm]	X	X	Displays the value of engine speed signal, which is input from ECM.
FUEL METER [lit.]	X	X	Displays the value, which processes a resistance signal from fuel gauge.
W TEMP METER [°C] or [°F]	X	X	Displays the value of engine coolant temperature signal, which is input from ECM.
ABS W/L [ON/OFF]		X	Displays [ON/OFF] condition of ABS warning lamp.
VDC/TCS IND [ON/OFF]		X	Displays [ON/OFF] condition of VDC/TCS OFF indicator lamp.
SLIP IND [ON/OFF]		X	Displays [ON/OFF] condition of SLIP indicator lamp.
BRAKE W/L [ON/OFF]		X	Displays [ON/OFF] condition of brake warning lamp.*
DOOR W/L [ON/OFF]		X	Displays [ON/OFF] condition of door warning lamp.
TRUNK/GLAS-H [ON/OFF]		X	Displays [ON/OFF] condition of trunk warning lamp.
HI-BEAM IND [ON/OFF]		X	Displays [ON/OFF] condition of high beam indicator.
TURN IND [ON/OFF]		X	Displays [ON/OFF] condition of turn indicator.
OIL W/L [ON/OFF]		X	Displays [ON/OFF] condition of oil pressure warning lamp.
MIL [ON/OFF]		X	Displays [ON/OFF] condition of malfunction indicator lamp.
CRUISE IND [ON/OFF]		X	Displays [ON/OFF] condition of CRUISE indicator.
SET IND [ON/OFF]		X	Displays [ON/OFF] condition of SET indicator.
ATC/T-AMT W/L [ON/OFF]		X	Displays [ON/OFF] condition of CVT warning lamp.
FUEL W/L [ON/OFF]		X	Displays [ON/OFF] condition of low-fuel warning lamp.
WASHER W/L [ON/OFF]		X	Displays [ON/OFF] condition of low washer fluid warning lamp.
AIR PRES W/L [ON/OFF]		X	Displays [ON/OFF] condition of tire pressure warning lamp.
KEY G W/L [ON/OFF]		X	Displays [ON/OFF] condition of key warning lamp.
LCD		X	Displays the value of Intelligent Key system message indication.
SHIFT IND [P, R, N, D, L]		X	Displays [P, R, N, D, L] range position of CVT.
M RANGE SW [ON/OFF]		X	Displays [ON/OFF] condition of manual mode range switch.
NM RANGE SW [ON/OFF]		X	Displays [ON/OFF] condition of except for manual mode range switch.
AT SFT UP SW [ON/OFF]		X	Displays [ON/OFF] condition of CVT shift-up switch.
AT SFT DWN SW [ON/OFF]		X	Displays [ON/OFF] condition of CVT shift-down switch.

DIAGNOSIS SYSTEM (METER)

< FUNCTION DIAGNOSIS >

Display item [Unit]	MAIN SIGNALS	SELECTION FROM MENU	Description	A
COMP F/B SIG [ON/OFF]		X	A/C compressor activation condition that ECM judges according to the water temperature and the acceleration degree.	A
PKB SW [ON/OFF]		X	Displays [ON/OFF] condition of parking brake switch.	B
BUCKLE SW [ON/OFF]		X	Displays [ON/OFF] condition of seat belt buckle switch LH.	B
BRAKE OIL SW [ON/OFF]		X	Displays [ON/OFF] condition of brake fluid level switch.	C
DISTANCE [km] or [mile]		X	Displays the value, which is calculated by vehicle speed signal, fuel gauge and fuel consumption from ECM.	C
OUTSIDE TEMP [°C]		X	Displays the ambient air temperature, which is input from ambient sensor.	D
FUEL LOW SIG [ON/OFF]		X	Displays [ON/OFF] condition of low-fuel warning signal.	D
BUZZER [ON/OFF]	X	X	Displays [ON/OFF] condition of buzzer.	E

NOTE:

Some items are not available due to vehicle specification.

*: The monitor will indicate "OFF" even though the brake warning lamp is on if either of the following conditions exist.

- The parking brake is engaged
- The brake fluid level is low

A
B
C
D
E
F
G
H
I
J
K
L
M
O
P

WCS

DIAGNOSIS SYSTEM (BCM)

< FUNCTION DIAGNOSIS >

DIAGNOSIS SYSTEM (BCM)

BUZZER

BUZZER : CONSULT-III Function (BCM-BUZZER)

INFOID:000000005511894

DATA MONITOR

Display item [Unit]	Description
PUSH SW [On/Off]	Status of push button ignition switch judged by BCM.
UNLK SEN -DR [On/Off]	Status of door lock assembly (door unlock sensor) judged by BCM.
VEH SPEED 1 [km/h]	Value of vehicle speed signal received from ABS actuator and electric unit (control unit) with CAN communication line.
KEY SW-SLOT [On/Off]	Status of key slot judged by BCM.
TAIL LAMP SW [On/Off]	Status of each switch judged by BCM using the combination SW readout function.
FR FOG SW [On/Off]	Status of front fog lamp switch judged by BCM.
DOOR SW -DR [On/Off]	Status of driver side door switch judged by BCM.

ACTIVE TEST

Display item [Unit]	Description
IGN KEY WARN ALM	The key warning chime operation can be checked by operating the relevant function (On/Off).
SEAT BELT WARN TEST	The seat belt warning chime operation can be checked by operating the relevant function (On/Off).
ID REGIST WARNING	The ID regist warning chime operation can be checked by operating the relevant function (On/Off).
LIGHT WARN ALM	The light warning chime operation can be checked by operating the relevant function (On/Off).

POWER SUPPLY AND GROUND CIRCUIT

< COMPONENT DIAGNOSIS >

COMPONENT DIAGNOSIS

POWER SUPPLY AND GROUND CIRCUIT COMBINATION METER

COMBINATION METER : Diagnosis Procedure

INFOID:000000005511896

Regarding Wiring Diagram information, refer to [WCS-32, "Wiring Diagram"](#).

1. CHECK FUSES

Check for blown combination meter fuses.

Unit	Power source	Fuse No.
Combination meter	Battery	11
	Ignition switch ON or START	4

Is the inspection result normal?

YES >> GO TO 2

NO >> If fuse is blown, be sure to eliminate cause of malfunction before installing new fuse.

2. POWER SUPPLY CIRCUIT CHECK

1. Disconnect combination meter connector.
2. Check voltage between combination meter harness connector M24 terminals 1, 2, and ground.

Terminals		(-)	Ignition switch position		
(+)			OFF	ON	START
Connector	Terminal	Ground			
M24	1		Battery voltage	Battery voltage	Battery voltage
	2	0V	Battery voltage	Battery voltage	

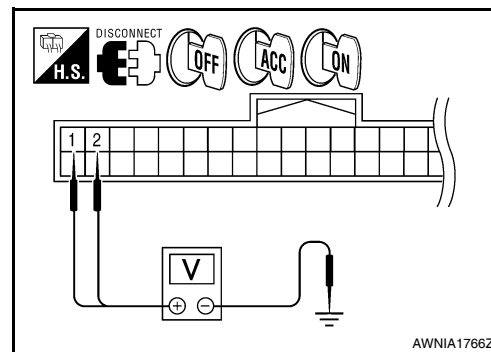

Is the inspection result normal?

YES >> GO TO 3

NO >> Check harness for open between combination meter and fuse.

3. GROUND CIRCUIT CHECK

1. Turn ignition switch OFF.
2. Check continuity between combination meter harness connector terminals 3, 4, 23 and ground.

Terminals		(-)	Continuity
(+)			
Connector	Terminal	Ground	Yes
M24	3		
	4		
	23		

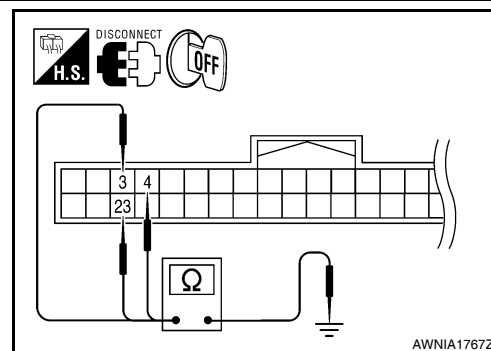

Is the inspection result normal?

YES >> Inspection End.

NO >> Check ground harness.

BCM (BODY CONTROL MODULE)

A
B
C
D
E
F
G
H
I
J
K
L
M

WCS

O
P

POWER SUPPLY AND GROUND CIRCUIT

< COMPONENT DIAGNOSIS >

BCM (BODY CONTROL MODULE) : Diagnosis Procedure

INFOID:000000005511895

Regarding Wiring Diagram information, refer to [WCS-76. "Wiring Diagram"](#).

1. CHECK FUSE AND FUSIBLE LINK

Check if the following BCM fuses or fusible link are blown.

Terminal No.	Signal name	Fuse and fusible link No.
1	Battery power supply	H
11		10
24		7

Is the fuse or fusible link blown?

YES >> Replace the blown fuse or fusible link after repairing the affected circuit.

NO >> GO TO 2

2. CHECK POWER SUPPLY CIRCUIT

1. Turn ignition switch OFF.
2. Disconnect BCM.
3. Check voltage between BCM harness connector and ground.

Terminals		Voltage (Approx.)
(+)	(-)	
BCM		Ground Battery voltage
Connector	Terminal	
M16 (A)	1	
M17 (B)	11	
M18 (C)	24	

Is the measurement normal?

YES >> GO TO 3

NO >> Repair or replace harness.

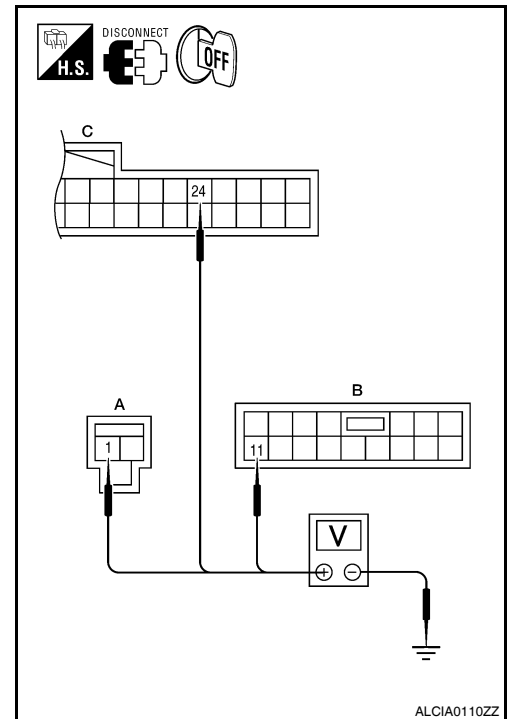

3. CHECK GROUND CIRCUIT

Check continuity between BCM harness connector and ground.

BCM		Ground	Continuity
Connector	Terminal		
M17	13		Yes

Does continuity exist?

YES >> Inspection End.

NO >> Repair or replace harness.

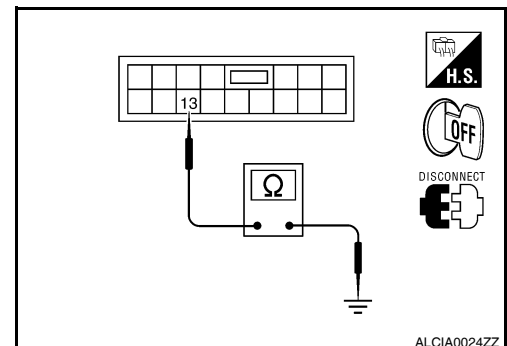

METER BUZZER CIRCUIT

< COMPONENT DIAGNOSIS >

METER BUZZER CIRCUIT

Description

INFOID:000000005459957

- The buzzer for warning chime system is installed in the combination meter.
- The combination meter sounds the alarm buzzer based on the signals transmitted from various units.

Component Function Check

INFOID:000000005459958

1. CHECK OPERATION OF METER BUZZER

1. Select "BUZZER" of "BCM" on CONSULT-III.
2. Perform "LIGHT WARN ALM" of "ACTIVE TEST".

Does meter buzzer activate?

- YES >> Inspection End.
NO >> Replace combination meter. Refer to [MWI-140, "Removal and Installation"](#).

Diagnosis Procedure

INFOID:000000005459959

1. CHECK POWER SUPPLY OF COMBINATION METER

Check power supply of combination meter. Refer to [MWI-37, "COMBINATION METER : Diagnosis Procedure"](#).

Is the inspection result normal?

- YES >> Inspection End.
NO >> Repair or replace harness.

A
B
C
D
E
F
G
H
I
J
K
L
M
O
P

WCS

SEAT BELT BUCKLE SWITCH SIGNAL CIRCUIT

< COMPONENT DIAGNOSIS >

SEAT BELT BUCKLE SWITCH SIGNAL CIRCUIT

Description

INFOID:000000005459960

Transmits a seat belt buckle switch signal to the combination meter.

Component Function Check

INFOID:000000005459961

1. CHECK COMBINATION METER INPUT SIGNAL

Select "DATA MONITOR" for "METER/M&A" and check the "BUCKLE SW" monitor value.

BUCKLE SW

When seat belt is fastened : OFF

When seat belt is unfastened : ON

>> Inspection End.

Diagnosis Procedure

INFOID:000000005459962

Regarding Wiring Diagram information, refer to [WCS-22. "Wiring Diagram"](#).

1. CHECK COMBINATION METER INPUT SIGNAL

1. Turn ignition switch ON.
2. Check voltage between combination meter harness connector M24 terminal 35 and ground.

35 - Ground

When driver seat belt is fastened : Approx. 12V

When driver seat belt is unfastened : Approx. 0V

Is the inspection result normal?

YES >> Replace combination meter. Refer to [MWI-140. "Removal and Installation"](#).

NO >> GO TO 2

2. CHECK SEAT BELT BUCKLE SWITCH CIRCUIT

1. Turn ignition switch OFF.
2. Disconnect combination meter and seat belt buckle switch LH.
3. Check continuity between combination meter harness connector M24 (A) terminal 35 and seat belt buckle switch LH harness connector B202 (B) terminal 1.

35 - 1 : Continuity should exist.

4. Check harness continuity between combination meter harness connector M24 (A) terminal 35 and ground.

35 - Ground : Continuity should not exist.

Is the inspection result normal?

YES >> GO TO 3

NO >> Repair or replace harness.

3. CHECK SEAT BELT BUCKLE SWITCH GROUND CIRCUIT

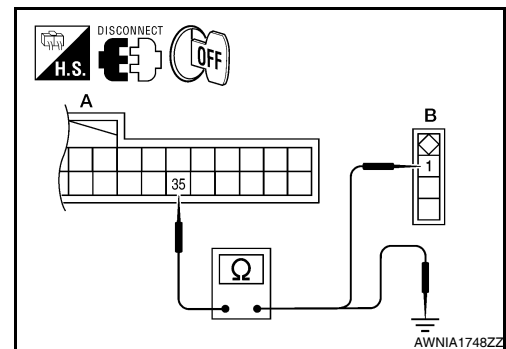
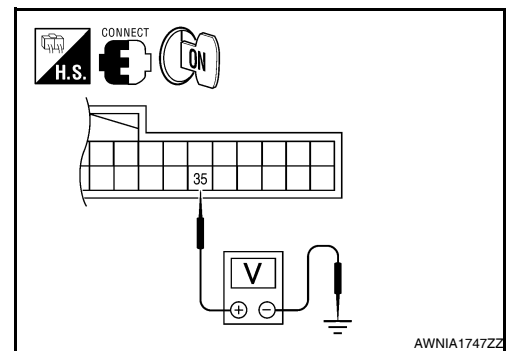

SEAT BELT BUCKLE SWITCH SIGNAL CIRCUIT

< COMPONENT DIAGNOSIS >

Check harness continuity between seat belt buckle switch LH harness connector B202 terminal 2 and ground.

2 - Ground : Continuity should exist.

Is the inspection result normal?

- YES >> Inspection End.
- NO >> Repair or replace harness.

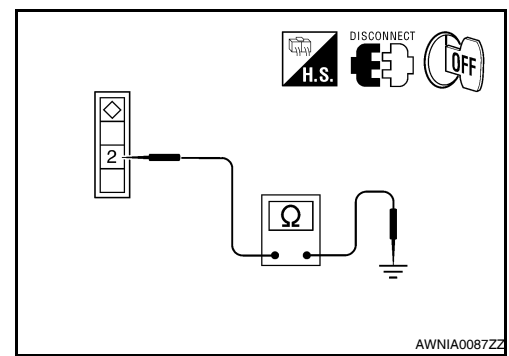

Component Inspection

1. CHECK SEAT BELT BUCKLE SWITCH

1. Turn ignition switch OFF.
2. Disconnect the seat belt buckle switch.
3. Check continuity between terminals 1 and 2.

1-2
When seat belt is fastened : Continuity should not exist.
When seat belt is unfastened : Continuity should exist.

Is the inspection result normal?

- YES >> Inspection End.
- NO >> Replace the seat belt buckle switch LH.

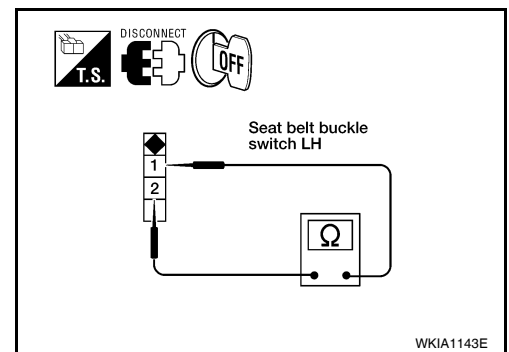

WARNING CHIME SYSTEM

< COMPONENT DIAGNOSIS >

WARNING CHIME SYSTEM

Wiring Diagram

INFOID:000000005459964

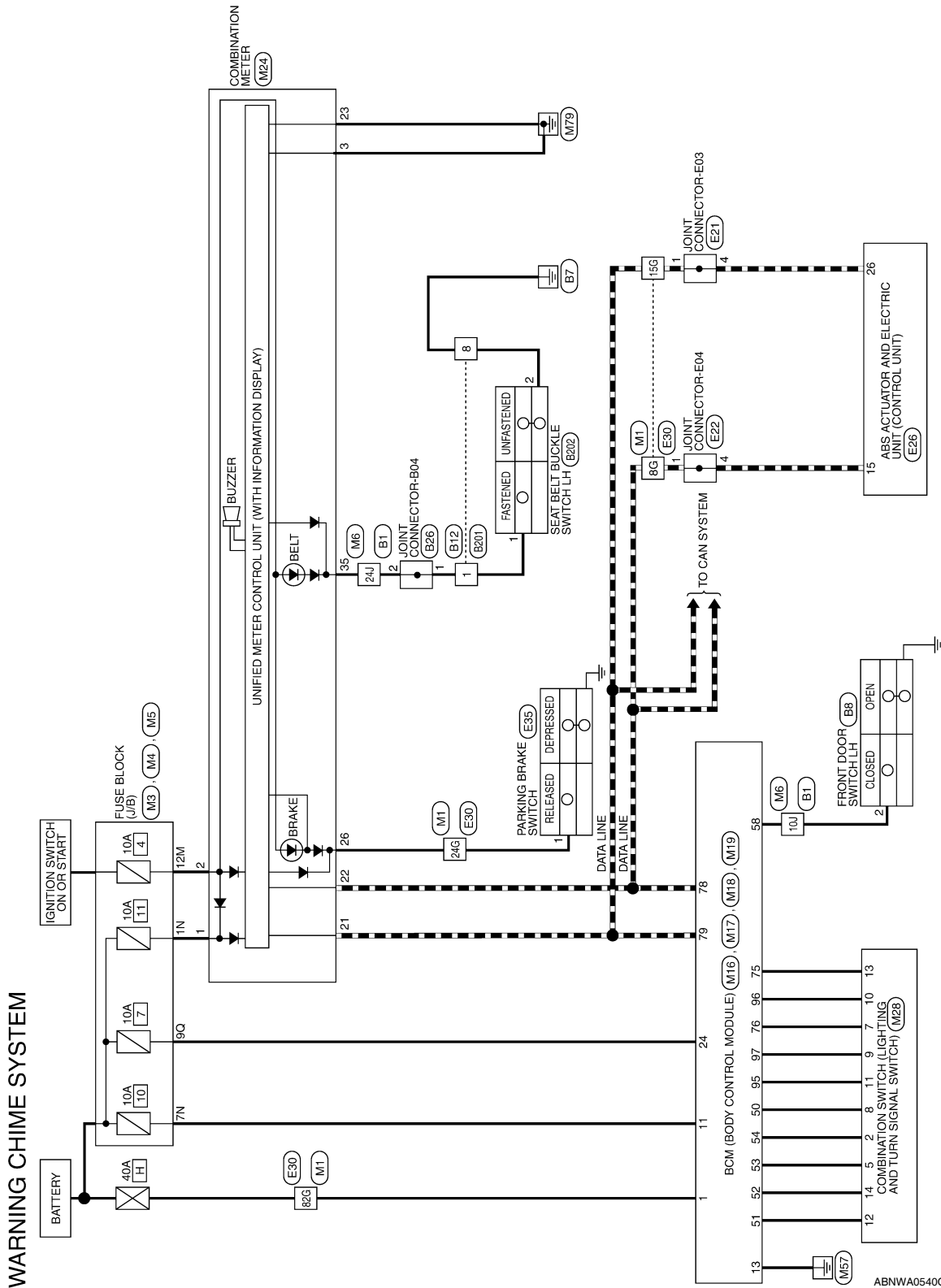

ABNWA0540GI

WARNING CHIME SYSTEM

< COMPONENT DIAGNOSIS >

WARNING CHIME SYSTEM CONNECTORS

Connector No.	M1
Connector Name	WIRE TO WIRE
Connector Color	WHITE

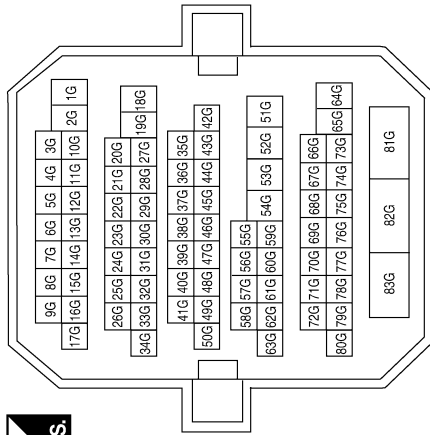

Terminal No.	Color of Wire	Signal Name
8G	P	-
15G	L	-
24G	G/R	-
82G	W/B	-

Connector No.	M3
Connector Name	FUSE BLOCK (J/B)
Connector Color	WHITE

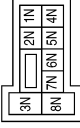

Terminal No.	Color of Wire	Signal Name
1N	W/L	-
7N	Y/R	-

Connector No.	M4
Connector Name	FUSE BLOCK (J/B)
Connector Color	WHITE

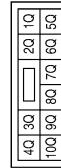

Terminal No.	Color of Wire	Signal Name
9Q	R/W	-

Connector No.	M5
Connector Name	FUSE BLOCK (J/B)
Connector Color	WHITE



Terminal No.	Color of Wire	Signal Name
12M	O	-

ABNIA1667GB

A
B
C
D
E
F
G
H
I
J
K
L
M
N
O
P

WCS

WARNING CHIME SYSTEM

< COMPONENT DIAGNOSIS >

Connector No.	M16
Connector Name	BCM (BODY CONTROL MODULE)
Connector Color	BLACK



Terminal No.	Color of Wire	Signal Name
1	W/B	BATT (F/L)

Terminal No.	Color of Wire	Signal Name
10J	SB	-
24J	W/B	-

Connector No.	M6
Connector Name	WIRE TO WIRE
Connector Color	WHITE

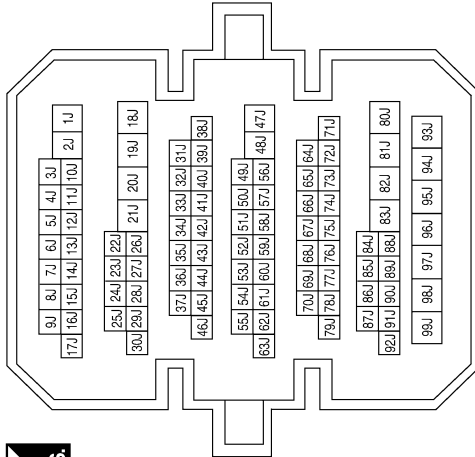

Terminal No.	Color of Wire	Signal Name
50	LG/B	OUT PUT 5
51	L/W	OUT PUT 1
52	G/B	OUT PUT 2
53	LG/R	OUT PUT 3
54	G/Y	OUT PUT 4
58	SB	DR DOOR SW

Connector No.	M18
Connector Name	BCM (BODY CONTROL MODULE)
Connector Color	GREEN



39	38	37	36	35	34	33	32	31	30	29	28	27	26	25	24	23	22	21	20	19	18	17	16	15	14	13	12	11	10	9	8	7	6	5	4
----	----	----	----	----	----	----	----	----	----	----	----	----	----	----	----	----	----	----	----	----	----	----	----	----	----	----	----	----	----	---	---	---	---	---	---

Connector No.	M17
Connector Name	BCM (BODY CONTROL MODULE)
Connector Color	WHITE

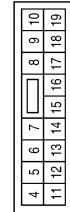

Terminal No.	Color of Wire	Signal Name
11	Y/R	BAT BCM FUSE
13	B	GND1

ABNIA1668GB

WARNING CHIME SYSTEM

< COMPONENT DIAGNOSIS >

Connector No.	M28
Connector Name	COMBINATION SWITCH
Connector Color	WHITE

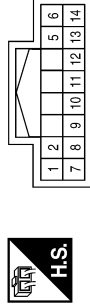

Terminal No.	Color of Wire	Signal Name
2	G/Y	OUTPUT 4
5	LG/R	OUTPUT 3
7	R/G	INPUT 3
8	LG/B	OUTPUT 5
9	R/B	INPUT 2
10	P/B	INPUT 4
11	R/W	INPUT 1
12	L/W	OUTPUT 1
13	R/Y	INPUT 5
14	G/B	OUTPUT 2

Connector No.	M24
Connector Name	COMBINATION METER
Connector Color	WHITE

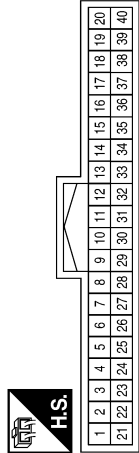

Terminal No.	Color of Wire	Signal Name
1	W/L	BAT
2	O	IGN
3	B	GND (POWER)
21	L	CAN-H
22	P	CAN-L
23	B	GND (CIRCUIT)
26	G/R	PKB
35	W/B	DR BELT

Connector No.	M19
Connector Name	BCM (BODY CONTROL MODULE)
Connector Color	BLACK



Terminal No.	Color of Wire	Signal Name
75	R/Y	INPUT 5
76	R/G	INPUT 3
78	P	CAN-L
79	L	CAN-H
95	R/W	INPUT 1
96	P/B	INPUT 4
97	R/B	INPUT 2

Connector No.	E26
Connector Name	ABS ACTUATOR AND ELECTRIC UNIT (CONTROL UNIT)
Connector Color	BLACK



Terminal No.	Color of Wire	Signal Name
15	P	CAN-L
26	L	CAN-H

Connector No.	E22
Connector Name	JOINT CONNECTOR-E04
Connector Color	WHITE



Terminal No.	Color of Wire	Signal Name
1	P	-
4	P	-

Connector No.	E21
Connector Name	JOINT CONNECTOR-E03
Connector Color	WHITE

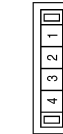

Terminal No.	Color of Wire	Signal Name
1	L	-
4	L	-

ABNIA1669GB

A
B
C
D
E
F
G
H
I
J
K
L
M
N
O
P

WCS

WARNING CHIME SYSTEM

< COMPONENT DIAGNOSIS >

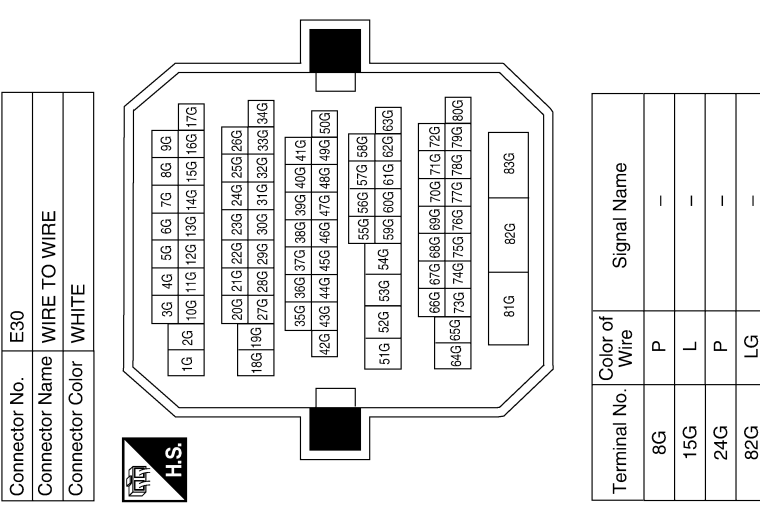
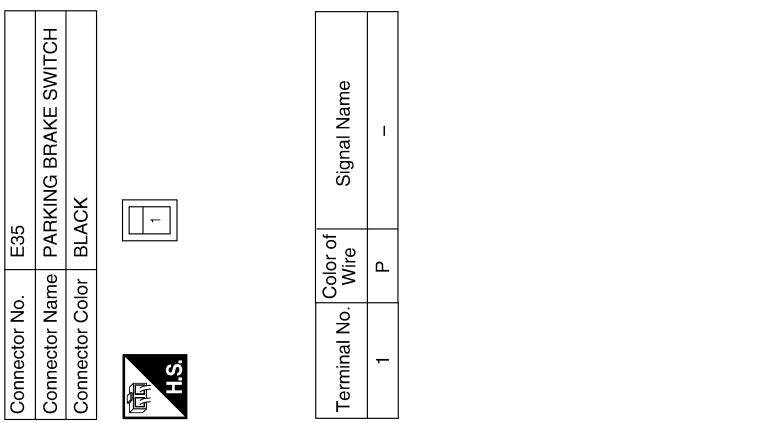
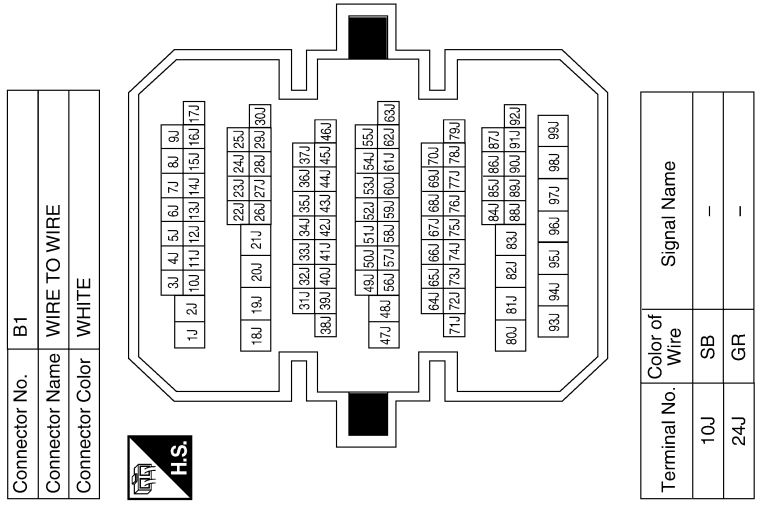

ABNIA1670GB

WARNING CHIME SYSTEM

< COMPONENT DIAGNOSIS >

Connector No.	B26
Connector Name	JOINT CONNECTOR-B04
Connector Color	WHITE



Terminal No.	Color of Wire	Signal Name
1	GR	-
2	GR	-

Connector No.	B12
Connector Name	WIRE TO WIRE
Connector Color	WHITE

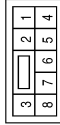

Terminal No.	Color of Wire	Signal Name
1	GR	-
8	BW	-

Connector No.	B8
Connector Name	FRONT DOOR SWITCH LH
Connector Color	WHITE

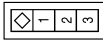

Terminal No.	Color of Wire	Signal Name
2	SB	-

Connector No.	B202
Connector Name	SEAT BELT BUCKLE SWITCH LH
Connector Color	WHITE

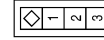

Terminal No.	Color of Wire	Signal Name
1	L	-
2	B	-

Connector No.	B201
Connector Name	WIRE TO WIRE
Connector Color	WHITE



Terminal No.	Color of Wire	Signal Name
1	L	-
8	B	-

ABNIA1671GB

A
B
C
D
E
F
G
H
I
J
K
L
M
N
O
P

WCS

COMBINATION METER

< ECU DIAGNOSIS >

ECU DIAGNOSIS

COMBINATION METER

Reference Value

INFOID:000000005511897

VALUES ON THE DIAGNOSIS TOOL

Monitor Item	Condition	Value/Status
SPEED METER [km/h or mph]	While driving	Displays the value of the vehicle speed signal.
SPEED OUTPUT [km/h or mph]	While driving	Displays the value of the vehicle speed signal which is transmitted to each unit with CAN communication.
ODO OUTPUT [kilometers or miles]	—	Equivalent to odometer reading in combination meter
TACHO METER [rpm]	While driving	Displays the value of engine speed signal which is input from the ECM.
FUEL METER [L]	—	Displays the value processed from a resistance signal from the fuel gauge.
W TEMP METER [°C] or [°F]	—	Displays the value of the engine coolant temperature signal which is input from the ECM.
ABS W/L	ABS warning lamp ON	ON
	ABS warning lamp OFF	OFF
VDC/TCS IND	VDC OFF indicator lamp ON	ON
	VDC OFF indicator lamp OFF	OFF
SLIP IND	SLIP Indicator lamp ON	ON
	SLIP indicator lamp OFF	OFF
BRAKE W/L*	Brake warning lamp ON	ON
	Brake warning lamp OFF	OFF
DOOR W/L	Door warning lamp ON	ON
	Door warning lamp OFF	OFF
TRUNK/GLAS-H	Trunk warning lamp ON	ON
	Trunk warning lamp OFF	OFF
HI-BEAM IND	High-beam indicator lamp ON	ON
	High-beam indicator lamp OFF	OFF
TURN IND	Turn signal indicator lamp ON	ON
	Turn signal indicator lamp OFF	OFF
OIL W/L	Oil pressure warning lamp ON	ON
	Oil pressure warning lamp OFF	OFF
MIL	Malfunction indicator lamp ON	ON
	Malfunction indicator lamp OFF	OFF
CRUISE IND	CRUISE indicator ON	ON
	CRUISE indicator OFF	OFF
SET IND	SET indicator ON	ON
	SET indicator OFF	OFF
ATC/T-AMT W/L	CVT warning lamp ON	ON
	CVT warning lamp OFF	OFF

COMBINATION METER

< ECU DIAGNOSIS >

Monitor Item	Condition	Value/Status	
FUEL W/L	Low-fuel warning lamp ON	ON	A
	Low-fuel warning lamp OFF	OFF	
WASHER W/L	Low washer fluid warning lamp ON	ON	B
	Low washer fluid warning lamp OFF	OFF	
AIR PRES W/L	Low tire pressure warning lamp ON	ON	C
	Low tire pressure warning lamp OFF	OFF	
KEY G W/L	Key warning lamp ON	ON	D
	Key warning lamp OFF	OFF	
LCD	Intelligent Key information received	Displays the value of Intelligent Key system message indication.	
SHIFT IND	Range position indicator P display	P	E
	Range position indicator R display	R	
	Range position indicator N display	N	F
	Range position indicator D display	D	
	Range position indicator L display	L	
M RANGE SW	Manual mode range switch ON	ON	G
	Manual mode range switch OFF	OFF	
NM RANGE SW	Except for manual mode range switch ON	ON	H
	Except for manual mode range switch OFF	OFF	
AT SFT UP SW	CVT shift-up switch ON	ON	I
	CVT shift-up switch OFF	OFF	
AT SFT DWN SW	CVT shift-down switch ON	ON	J
	CVT shift-down switch OFF	OFF	
COMP F/B SIG	A/C compressor ON	Displays the A/C compressor activation condition [ON/OFF] the ECM judges according to the water temperature and the acceleration degree.	K
	A/C compressor OFF		
PKB SW	Parking brake switch ON	ON	L
	Parking brake switch OFF	OFF	
BUCKLE SW	Seat belt (driver side) not fastened	ON	M
	Seat belt (driver side) fastened	OFF	
BRAKE OIL SW	Brake fluid level switch ON	ON	
	Brake fluid level switch OFF	OFF	
DISTANCE [kilometers or miles]	—	Displays the value which is calculated by vehicle speed signal, fuel gauge and fuel consumption from ECM.	WCS
OUTSIDE TEMP [°C] or [°F]	—	Displays the ambient air temperature which is input from the ambient sensor.	
FUEL LOW SIG	Low fuel warning displayed	ON	O
	Low fuel warning not displayed	OFF	
BUZZER	Buzzer ON	ON	P
	Buzzer OFF	OFF	

NOTE:

* The monitor will indicate "OFF" even though the brake warning lamp is on if either of the following conditions exist:

- The parking brake is engaged
- The brake fluid level is low

COMBINATION METER

< ECU DIAGNOSIS >

TERMINAL LAYOUT

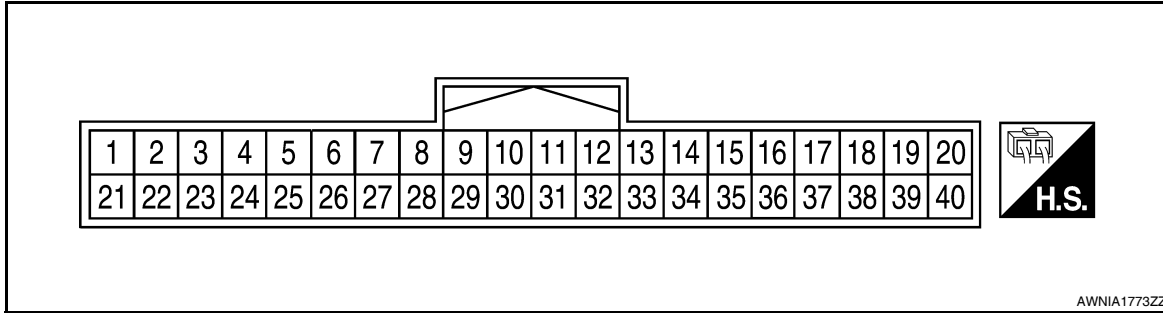

PHYSICAL VALUES

Terminal	Wire color	Item	Condition		Reference value (V) (Approx.)
			Ignition switch	Operation or condition	
1	W/L	Battery power supply	—	—	Battery voltage
2	O	Ignition switch ON or START	ON	—	Battery voltage
3	B	Ground (Power)	—	—	0
4	B	Ground (Illumination)			
5	B	Illumination output	—	—	Refer to INL-9, "System Description" .
10	O/L	Mode switch ground	ON	—	0
11	L/R	Mode switch A	ON	Switch pressed	0
				Switch released	5
12	B/R	Mode switch B	ON	Switch pressed	0
				Switch released	5
15	BR/W	Air bag warning lamp input	ON	Air bag warning lamp ON	3
				Air bag warning lamp OFF	0
18	O/B	Ambient sensor signal	ON	—	0 - 5 (Based on ambient temperature)
19	P	Ambient sensor power	ON	—	5
20	B/Y	Ambient sensor ground	ON	—	0
21	L	CAN-H	—	—	—
22	P	CAN-L	—	—	—
23	B	Ground (Circuit)	—	—	0
24	B/W	Fuel level sensor ground	ON	—	0
25	BR	Generator	ON	Generator voltage low	0
				Generator voltage normal	Battery voltage
26	G/R	Parking brake switch	ON	Parking brake depressed	0
				Parking brake released	Battery voltage
27	V	Brake fluid level switch	ON	Brake fluid level low	0
				Brake fluid level normal	Battery voltage
28	L/O	Security indicator input	OFF	Security indicator ON	0
				Security indicator OFF	Battery voltage
29	R	Washer fluid level switch	ON	Washer fluid level low	0
				Washer fluid level normal	Battery voltage
30	L/B	Vehicle speed signal output (2-pulse)	ON	Speedometer operated [When vehicle speed is approx. 20 km/h (12 MPH)]	240 Hz

COMBINATION METER

< ECU DIAGNOSIS >

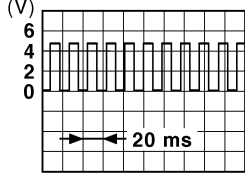
Terminal	Wire color	Item	Condition		Reference value (V) (Approx.)
			Ignition switch	Operation or condition	
31	V/W	Vehicle speed signal output (8-pulse)	ON	Speedometer operated [When vehicle speed is approx. 40 km/h (25 MPH)]	NOTE: Maximum voltage may be 12V due to specifications (connected units). 
34	G/B	Fuel level sensor signal	—	—	Refer to MWI-15, "FUEL GAUGE : System Description" .
35	W/B	Seat belt buckle switch LH	ON	Unfastened (ON)	0
				Fastened (OFF)	Battery voltage
36	L/W	Seat belt buckle switch RH	ON	Unfastened (ON)	0
				Fastened (OFF)	Battery voltage
37	G	Not M range	ON	Manual mode switch OFF	0
				Manual mode switch ON	Battery voltage
38	BR	AT shift down	ON	• Manual mode switch ON • Shift down operation	0
				Other than above	Battery voltage
39	W	AT shift up	ON	• Manual mode switch ON • Shift up operation	0
				Other than above	Battery voltage
40	LG/R	M range	ON	Manual mode switch OFF	Battery voltage
				Manual mode switch ON	0
49	G	Paddle shift signal (shift down)	ON	Shift down operation	0
				Switch released	Battery voltage
50	O	Paddle shift signal (shift up)	ON	Shift up operation	0
				Switch released	Battery voltage

A
B
C
D
E
F
G
H
I
J
K
L

M

WCS

O

P

COMBINATION METER

< ECU DIAGNOSIS >

Wiring Diagram

INFOID:000000005511898

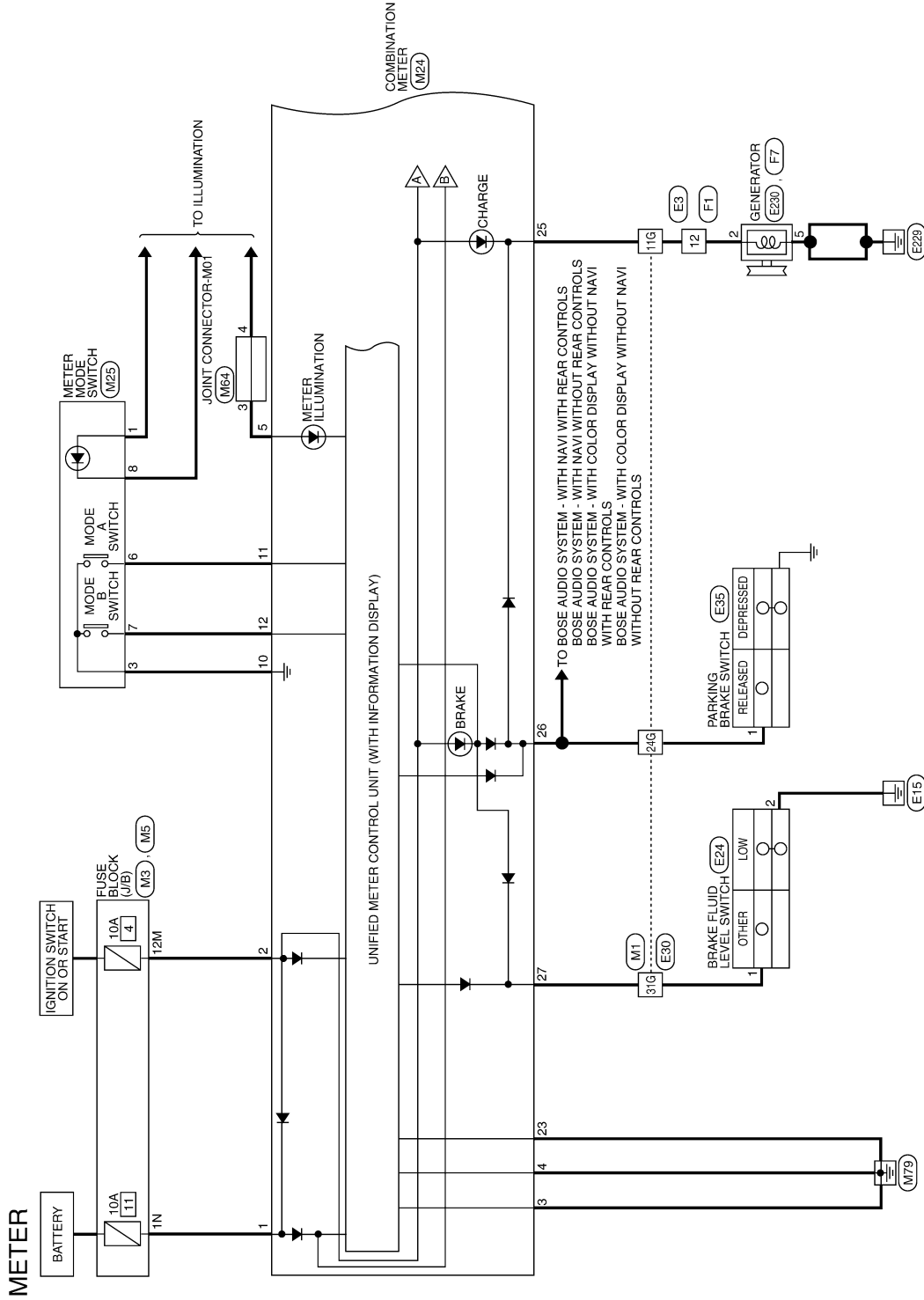

ABNWA0541GI

COMBINATION METER

< ECU DIAGNOSIS >

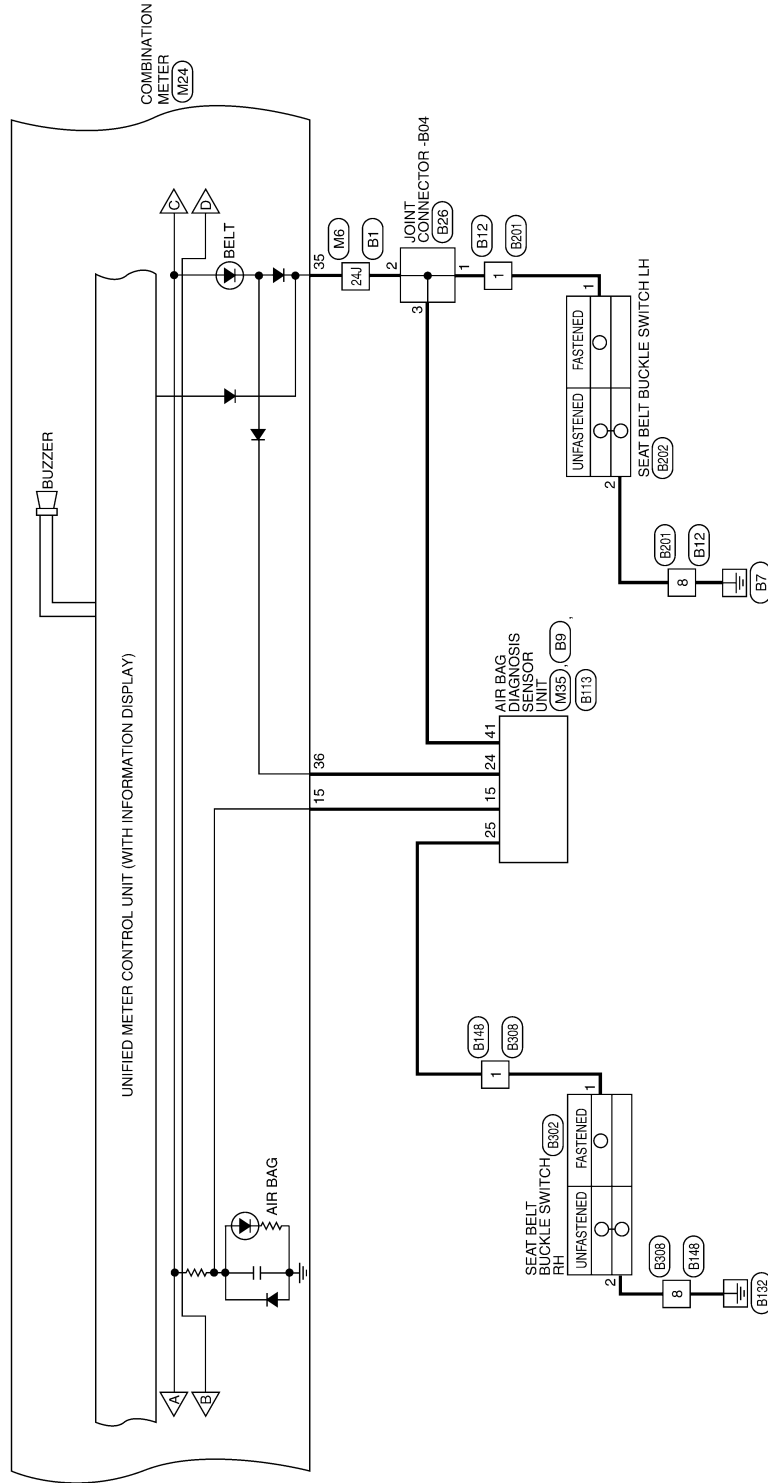

ABNWA0542Gf

A
B
C
D
E
F
G
H
I
J
K
L
M
O
P

WCS

COMBINATION METER

< ECU DIAGNOSIS >

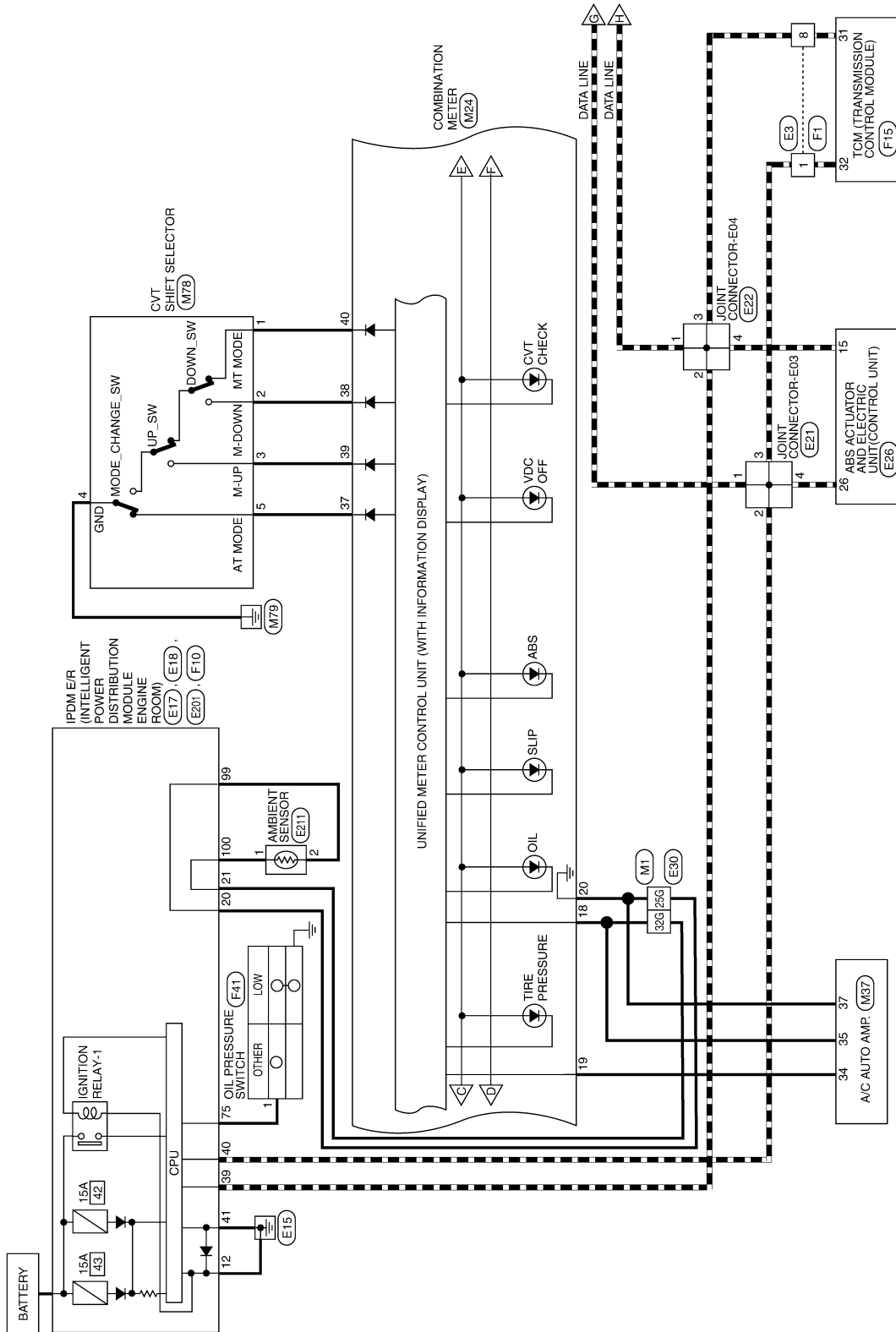

ABNWA0543Gf

COMBINATION METER

< ECU DIAGNOSIS >

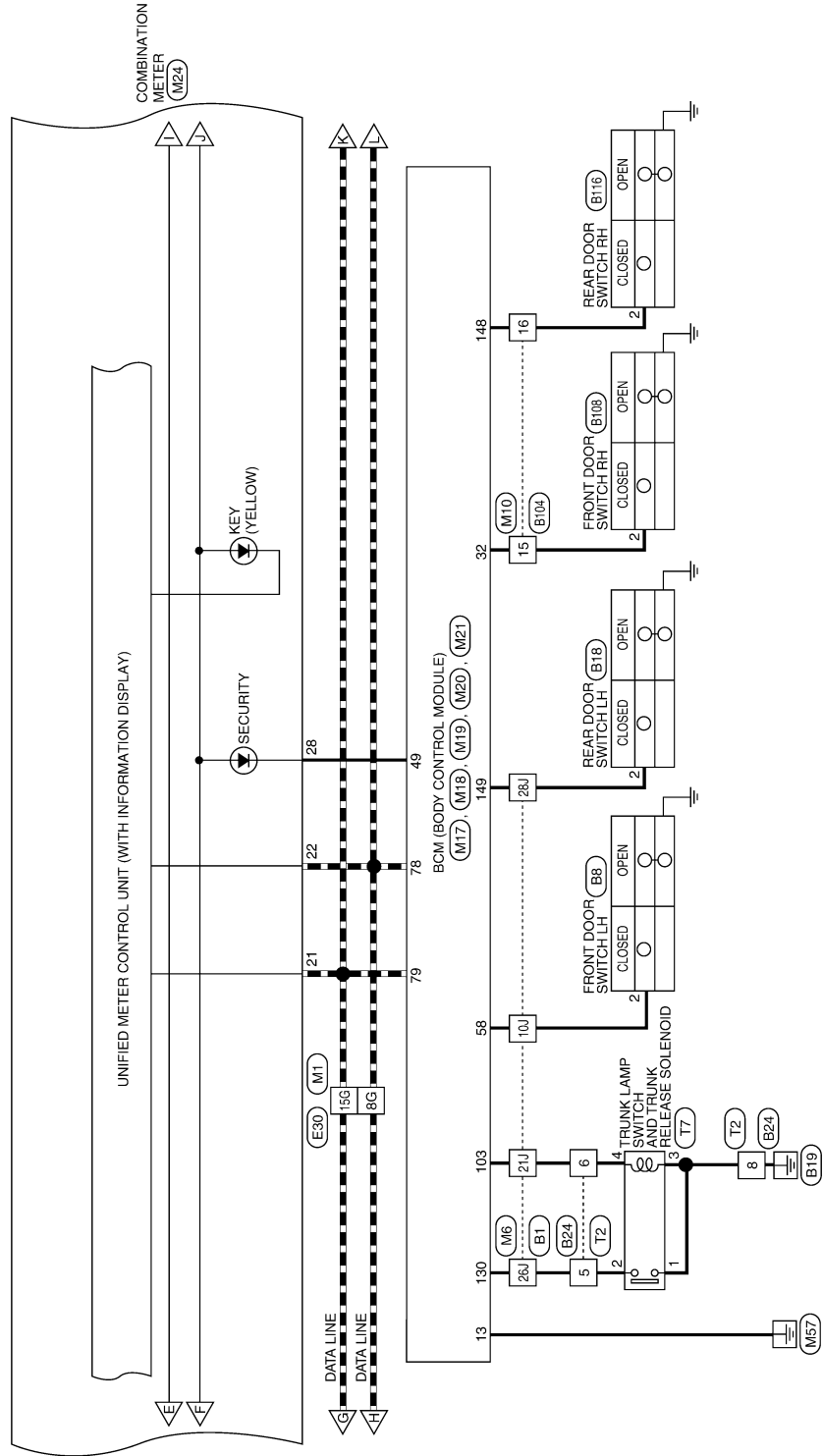

ABNWA0544Gf

A
B
C
D
E
F
G
H
I
J
K
L
M
WCS
O
P

COMBINATION METER

< ECU DIAGNOSIS >

- ◊AD◊ : WITH AUTOMATIC DRIVE POSITIONER
- ◊PJ◊ : WITH PADDLE SHIFT
- ◊XA◊ : WITHOUT AUTOMATIC DRIVE POSITIONER

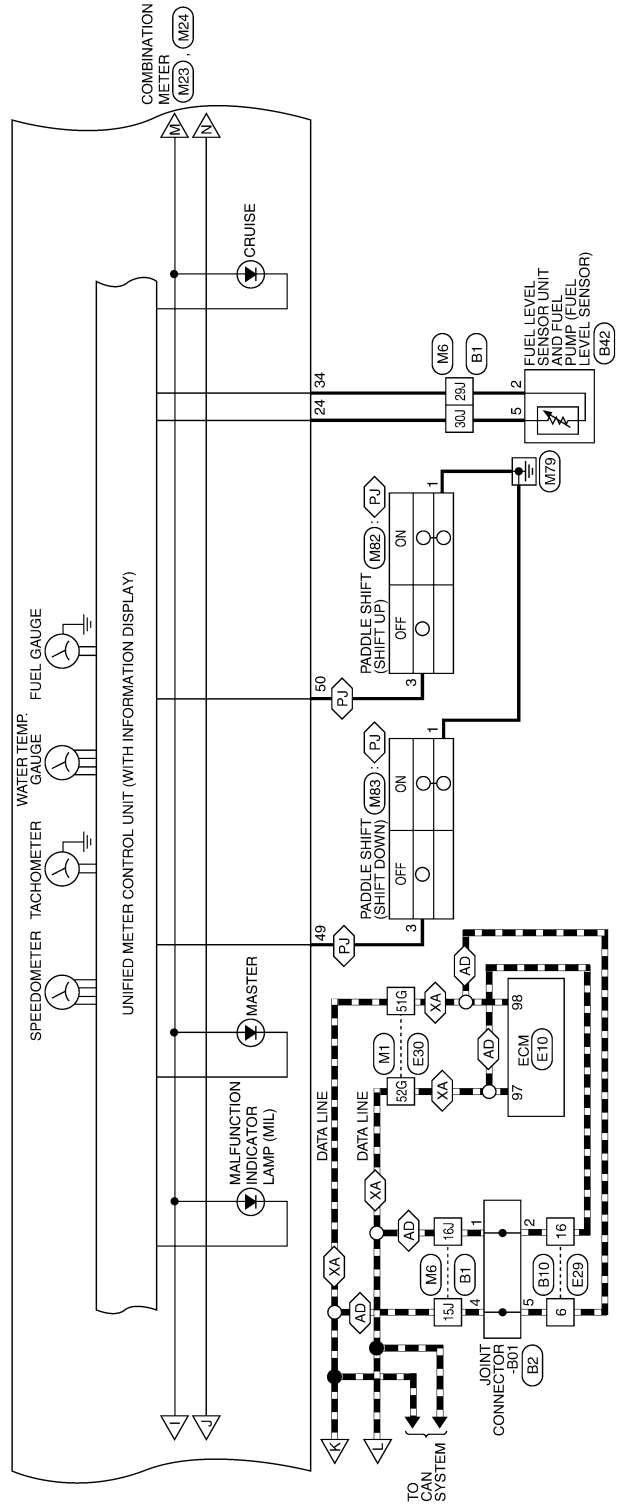

ABNWA0545G1

COMBINATION METER

< ECU DIAGNOSIS >

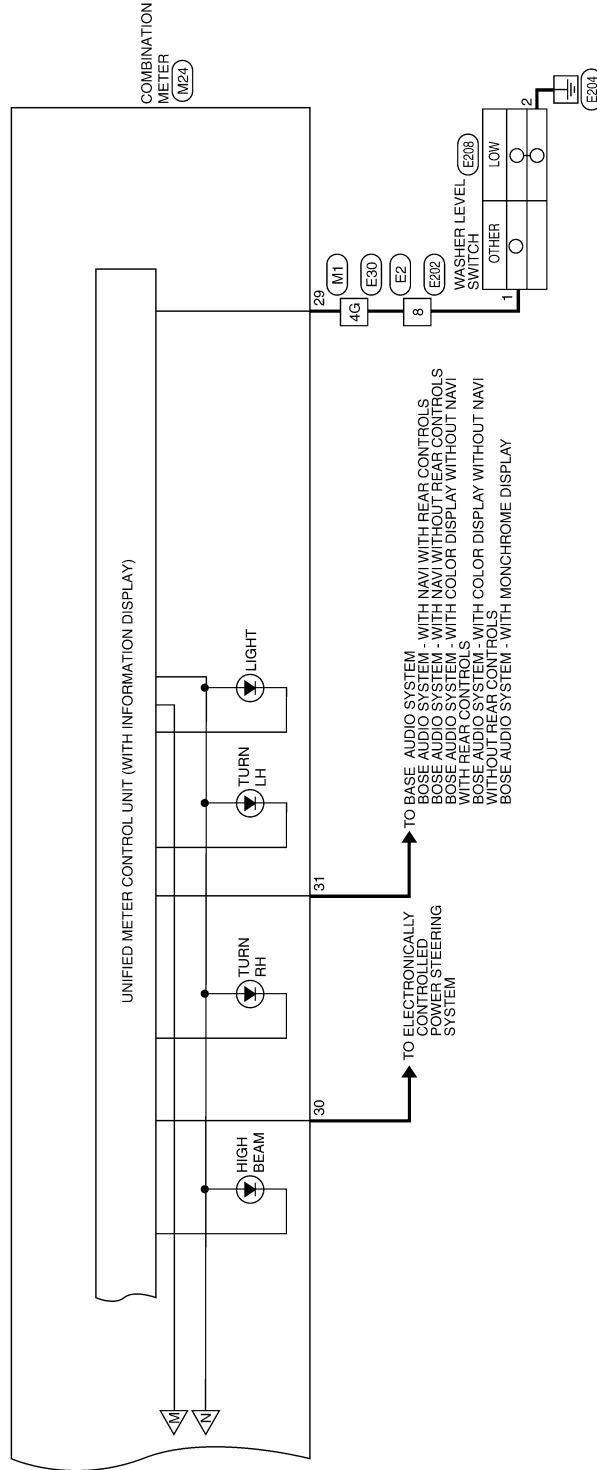

ABNWA0546Gf

A
B
C
D
E
F
G
H
I
J
K
L
M
O
P

WCS

COMBINATION METER

< ECU DIAGNOSIS >

METER CONNECTORS

Connector No.	M1
Connector Name	WIRE TO WIRE
Connector Color	WHITE

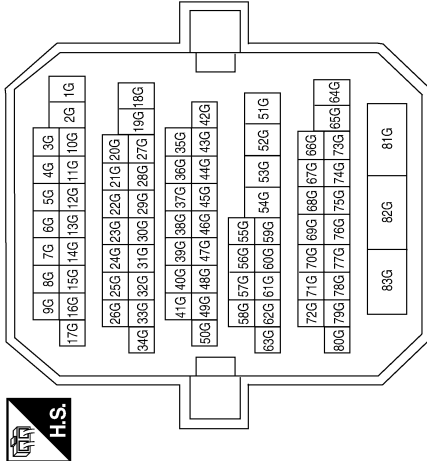

Terminal No.	Color of Wire	Signal Name
4G	R	-
8G	P	-
11G	BR	-
15G	L	-
24G	G/R	-
25G	B/Y	-
31G	V	-
32G	O/B	-
51G	L	-
52G	P	-

Connector No.	M3
Connector Name	FUSE BLOCK (J/B)
Connector Color	WHITE

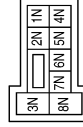

Terminal No.	Color of Wire	Signal Name
1N	W/L	-

Connector No.	M5
Connector Name	FUSE BLOCK (J/B)
Connector Color	WHITE

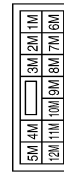

Terminal No.	Color of Wire	Signal Name
12M	O	-

ABNIA0415GB

COMBINATION METER

< ECU DIAGNOSIS >

Connector No.	M10
Connector Name	WIRE TO WIRE
Connector Color	WHITE

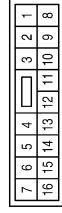

Terminal No.	Color of Wire	Signal Name
15	R/B	-
16	R/W	-

Terminal No.	Color of Wire	Signal Name
10J	SB	-
15J	L	-
16J	P	-
21J	V	-
24J	W/B	-
26J	W	-
28J	R/B	-
29J	G/B	-
30J	B/W	-

Connector No.	M6
Connector Name	WIRE TO WIRE
Connector Color	WHITE

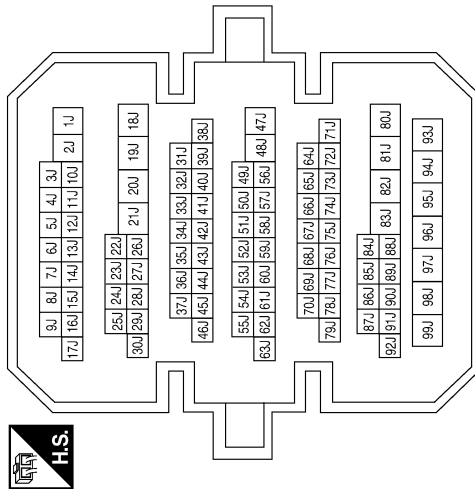

Connector No.	M19
Connector Name	BCM (BODY CONTROL MODULE)
Connector Color	BLACK

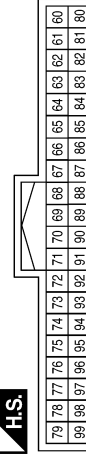

Terminal No.	Color of Wire	Signal Name
78	P	CAN-L
79	L	CAN-H

Connector No.	M18
Connector Name	BCM (BODY CONTROL MODULE)
Connector Color	GREEN

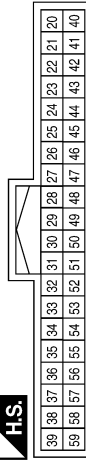

Terminal No.	Color of Wire	Signal Name
32	R/B	AS DOOR SW 1
49	L/O	IMMO LED (SECURITY INDICATOR)
58	SB	DR DOOR SW

Connector No.	M17
Connector Name	BCM (BODY CONTROL MODULE)
Connector Color	WHITE

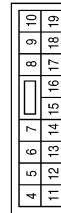

Terminal No.	Color of Wire	Signal Name
13	B	GND1

A
B
C
D
E
F
G
H
I
J
K
L
M
N
O
P

WCS

COMBINATION METER

< ECU DIAGNOSIS >

Connector No.	M23
Connector Name	COMBINATION METER
Connector Color	WHITE

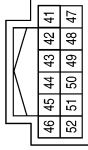

Terminal No.	Color of Wire	Signal Name
41	-	-
42	-	-
43	-	-
44	-	-
45	-	-
46	-	-
47	-	-
48	-	-
49	G	STRG SHIFT DOWN SW
50	O	STRG SHIFT UP SW
51	-	-
52	-	-

Connector No.	M21
Connector Name	BCM (BODY CONTROL MODULE)
Connector Color	GRAY

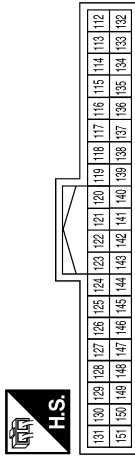

Terminal No.	Color of Wire	Signal Name
130	W	TRUNK SW
148	R/W	RR DOOR SW
149	R/B	RL DOOR SW

Connector No.	M20
Connector Name	BCM (BODY CONTROL MODULE)
Connector Color	WHITE

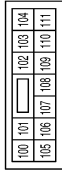

Terminal No.	Color of Wire	Signal Name
103	V	CDL BACK TRUNK

ABNIA0417GB

COMBINATION METER

< ECU DIAGNOSIS >

Connector No.	M25
Connector Name	METER MODE SWITCH
Connector Color	WHITE

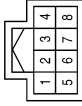

Terminal No.	Color of Wire	Signal Name
1	R/L	SW ILL POWER
3	O/L	SW GND
6	L/R	MODE SW A
7	B/R	MODE SW B
8	R/Y	SW ILL GND

Terminal No.	Color of Wire	Signal Name
17	-	-
18	O/B	OUTSIDE SENDER
19	P	OUTSIDE SENDER VAC
20	B/Y	OUTSIDE SENDER GND
21	L	CAN-H
22	P	CAN-L
23	B	GND (CIRCUIT)
24	B/W	GND (FUEL SENSOR)
25	BR	CHG
26	G/R	PKB
27	V	BRAKE OIL IN
28	L/O	SECURITY
29	R	LOW WASH FLUID SW
30	L/B	2P/R OUT
31	V/W	8P/R OUT
32	-	-
33	-	-
34	G/B	FUEL SENSOR
35	W/B	DR BELT
36	L/W	AS BELT
37	G	NOT M RANGE
38	BR	AT SHIFT DOWN
39	W	AT SHIFT UP
40	LG/R	M RANGE

Connector No.	M24
Connector Name	COMBINATION METER
Connector Color	WHITE

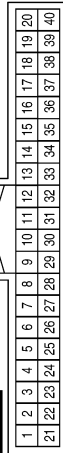

Terminal No.	Color of Wire	Signal Name
1	W/L	BAT
2	O	IGN
3	B	GND (POWER)
4	B	GND (ILL)
5	B	ILL OUTPUT
6	-	-
7	-	-
8	-	-
9	-	-
10	O/L	GND (SATELLITE SW)
11	L/R	MODE A SW
12	B/R	MODE B SW
13	-	-
14	-	-
15	BR/W	AIR BAG
16	-	-

ABNIA0418GB

A
B
C
D
E
F
G
H
I
J
K
L
M
O
P

WCS

COMBINATION METER

< ECU DIAGNOSIS >

Connector No.	M64
Connector Name	JOINT CONNECTOR-M01
Connector Color	WHITE



Terminal No.	Color of Wire	Signal Name
3	B	-
4	R/Y	-

Connector No.	M37
Connector Name	A/C AUTO AMP.
Connector Color	WHITE

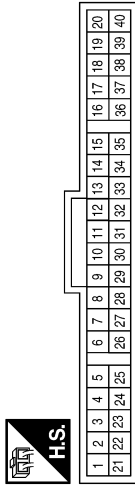

Terminal No.	Color of Wire	Signal Name
34	P	AMB POWER
35	O/B	AMB SENS
37	B/Y	SENS GND

Connector No.	M35
Connector Name	AIR BAG DIAGNOSIS SENSOR UNIT
Connector Color	YELLOW

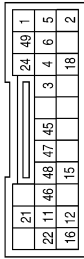

Terminal No.	Color of Wire	Signal Name
15	BR/W	AIRBAG W/L
24	L/W	SEAT BELT REMINDER

Connector No.	M83
Connector Name	PADDLE SHIFTER (SHIFT DOWN)
Connector Color	WHITE

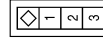

Terminal No.	Color of Wire	Signal Name
1	B	-
3	G	-

Connector No.	M82
Connector Name	PADDLE SHIFTER (SHIFT UP)
Connector Color	WHITE



Terminal No.	Color of Wire	Signal Name
1	B	-
3	O	-

Connector No.	M78
Connector Name	CVT SHIFT SELECTOR
Connector Color	WHITE

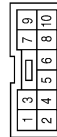

Terminal No.	Color of Wire	Signal Name
1	LG/R	MT MODE
2	BR	M DOWN
3	W	M UP
4	B	GND
5	G	AT MODE

ABNIA1673GB

COMBINATION METER

< ECU DIAGNOSIS >

Connector No.	E10
Connector Name	ECM
Connector Color	BLACK

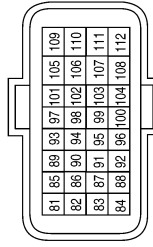

Terminal No.	Color of Wire	Signal Name
97	P	CAN-L
98	L	CAN-H

Connector No.	E3
Connector Name	WIRE TO WIRE
Connector Color	WHITE

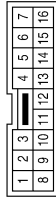

Terminal No.	Color of Wire	Signal Name
1	L	-
8	P	-
12	LG	-

Connector No.	E2
Connector Name	WIRE TO WIRE
Connector Color	WHITE

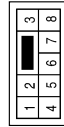

Terminal No.	Color of Wire	Signal Name
8	V	-

Connector No.	E18
Connector Name	IPDM E/R (INTELLIGENT POWER DISTRIBUTION MODULE ENGINE ROOM)
Connector Color	WHITE

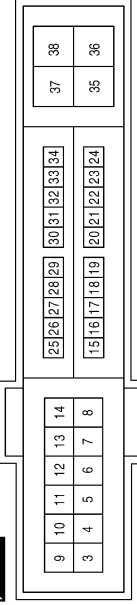

Terminal No.	Color of Wire	Signal Name
12	B	GND (POWER)
20	L	AMB SENS GND-E/R
21	LG	AMB SENS SIG-E/R

Connector No.	E17
Connector Name	IPDM E/R (INTELLIGENT POWER DISTRIBUTION MODULE ENGINE ROOM)
Connector Color	WHITE

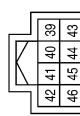

Terminal No.	Color of Wire	Signal Name
39	P	CAN-L
40	L	CAN-H
41	B	GND (SIGNAL)

ABNIA0979GB

A
B
C
D
E
F
G
H
I
J
K
L
M
N
O
P

WCS

COMBINATION METER

< ECU DIAGNOSIS >

Connector No.	E21
Connector Name	JOINT CONNECTOR-E03
Connector Color	WHITE



Terminal No.	Color of Wire	Signal Name
1	L	-
2	L	-
3	L	-
4	L	-

Connector No.	E22
Connector Name	JOINT CONNECTOR-E04
Connector Color	WHITE



Terminal No.	Color of Wire	Signal Name
1	P	-
2	P	-
3	P	-
4	P	-

Connector No.	E24
Connector Name	BRAKE FLUID LEVEL SWITCH
Connector Color	GRAY



Terminal No.	Color of Wire	Signal Name
1	V	-
2	B/Y	-

Connector No.	E26
Connector Name	ABS ACTUATOR AND ELECTRIC UNIT (CONTROL UNIT)
Connector Color	BLACK

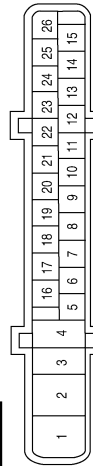

Terminal No.	Color of Wire	Signal Name
15	P	CAN-L
26	L	CAN-H

Connector No.	E29
Connector Name	WIRE TO WIRE
Connector Color	WHITE

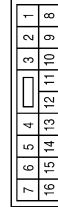

Terminal No.	Color of Wire	Signal Name
6	L	-
16	P	-

COMBINATION METER

< ECU DIAGNOSIS >

Connector No.	E35
Connector Name	PARKING BRAKE SWITCH
Connector Color	BLACK



Terminal No.	Color of Wire	Signal Name
1	P	-

Terminal No.	Color of Wire	Signal Name
4G	V	-
8G	P	-
11G	LG	-
15G	L	-
24G	P	-
25G	L	-
31G	V	-
32G	LG	-
51G	L	-
52G	P	-

Connector No.	E30
Connector Name	WIRE TO WIRE
Connector Color	WHITE

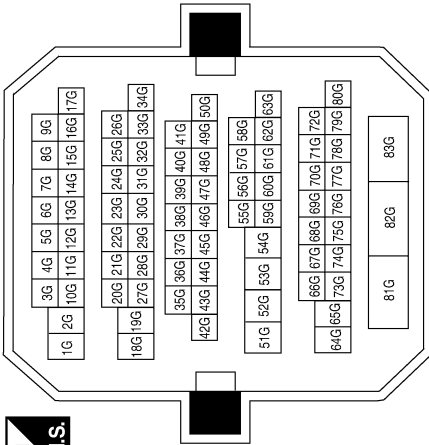

Connector No.	E208
Connector Name	WASHER LEVEL SWITCH
Connector Color	WHITE



Terminal No.	Color of Wire	Signal Name
1	R	-
2	B	-

Connector No.	E202
Connector Name	WIRE TO WIRE
Connector Color	WHITE

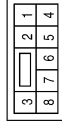

Terminal No.	Color of Wire	Signal Name
8	R	-

Connector No.	E201
Connector Name	IPDM E/R (INTELLIGENT POWER DISTRIBUTION MODULE ENGINE ROOM)
Connector Color	WHITE

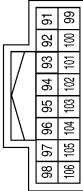

Terminal No.	Color of Wire	Signal Name
99	BR/W	AMB SENS GND-FEM
100	SB	AMB SENS SIG-FEM

A
B
C
D
E
F
G
H
I
J
K
L
M
N
O
P

WCS

COMBINATION METER

< ECU DIAGNOSIS >

Connector No.	E211
Connector Name	AMBIENT SENSOR
Connector Color	BLACK



Terminal No.	Color of Wire	Signal Name
1	SB	-
2	BRW	-

Connector No.	E230
Connector Name	GENERATOR
Connector Color	-



Terminal No.	Color of Wire	Signal Name
5	B	-

Connector No.	F1
Connector Name	WIRE TO WIRE
Connector Color	WHITE

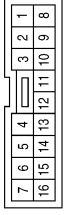

Terminal No.	Color of Wire	Signal Name
1	L	-
8	P	-
12	BR	-

Connector No.	F7
Connector Name	GENERATOR
Connector Color	BLACK



Terminal No.	Color of Wire	Signal Name
2	BR	-

Connector No.	F10
Connector Name	IPDM E/R (INTELLIGENT POWER DISTRIBUTION MODULE ENGINE ROOM)
Connector Color	WHITE

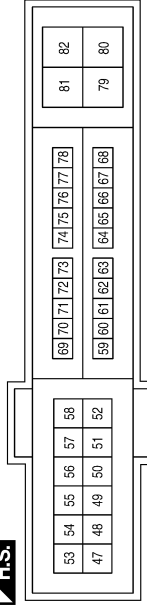

Terminal No.	Color of Wire	Signal Name
75	LG	OIL PRESSURE SW

COMBINATION METER

< ECU DIAGNOSIS >

Connector No.	F41
Connector Name	OIL PRESSURE SWITCH
Connector Color	GRAY



Terminal No.	Wire	Signal Name
1	LG	-

Connector No.	F15
Connector Name	TCM (TRANSMISSION CONTROL MODULE)
Connector Color	BLACK

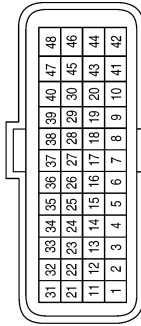

Terminal No.	Color of Wire	Signal Name
31	P	CAN-L
32	L	CAN-H

Connector No.	B2
Connector Name	JOINT CONNECTOR-B01
Connector Color	BLACK

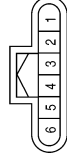

Terminal No.	Color of Wire	Signal Name
1	P	-
2	P	-
4	L	-
5	L	-

Terminal No.	Color of Wire	Signal Name
10J	SB	-
15J	L	-
16J	P	-
21J	V	-
24J	GR	-
26J	W	-
28J	BR	-
29J	V	-
30J	B	-

Connector No.	B1
Connector Name	WIRE TO WIRE
Connector Color	WHITE

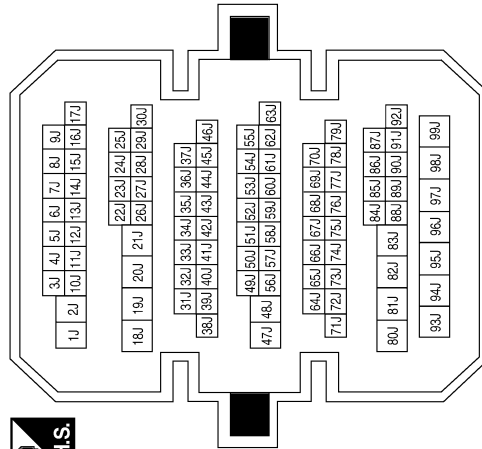

ABNIA0424GB

A
B
C
D
E
F
G
H
I
J
K
L
M
N
O
P

WCS

COMBINATION METER

< ECU DIAGNOSIS >

Connector No.	B8
Connector Name	FRONT DOOR SWITCH LH
Connector Color	WHITE



Terminal No.	2	Color of Wire	SB	Signal Name	-
--------------	---	---------------	----	-------------	---

Connector No.	B9
Connector Name	AIR BAG DIAGNOSIS SENSOR UNIT
Connector Color	YELLOW

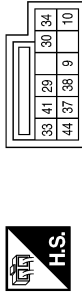

Terminal No.	41	Color of Wire	GR	Signal Name	LH BUCKLE SW INPUT
--------------	----	---------------	----	-------------	--------------------

Connector No.	B10
Connector Name	WIRE TO WIRE
Connector Color	WHITE

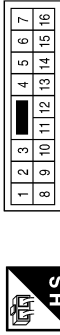

Terminal No.	6	Color of Wire	L	Signal Name	-
	16	Color of Wire	P	Signal Name	-

Connector No.	B12
Connector Name	WIRE TO WIRE
Connector Color	WHITE



Terminal No.	1	Color of Wire	GR	Signal Name	-
	8	Color of Wire	B/W	Signal Name	-

Connector No.	B18
Connector Name	REAR DOOR SWITCH LH
Connector Color	WHITE



Terminal No.	2	Color of Wire	BR	Signal Name	-
--------------	---	---------------	----	-------------	---

Connector No.	B24
Connector Name	WIRE TO WIRE
Connector Color	WHITE



Terminal No.	5	Color of Wire	W	Signal Name	-
	6	Color of Wire	V	Signal Name	-
	8	Color of Wire	B	Signal Name	-

COMBINATION METER

< ECU DIAGNOSIS >

Connector No.	B26
Connector Name	JOINT CONNECTOR-B04
Connector Color	WHITE



Terminal No.	Color of Wire	Signal Name
1	GR	-
2	GR	-
3	GR	-

Connector No.	B42
Connector Name	FUEL LEVEL SENSOR UNIT AND FUEL PUMP
Connector Color	GRAY

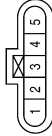

Terminal No.	Color of Wire	Signal Name
2	V	FUEL GND
5	B	FUEL SIGNAL

Connector No.	B104
Connector Name	WIRE TO WIRE
Connector Color	WHITE

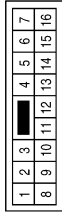

Terminal No.	Color of Wire	Signal Name
15	GR	-
16	B	-

Connector No.	B108
Connector Name	FRONT DOOR SWITCH RH
Connector Color	WHITE

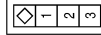

Terminal No.	Color of Wire	Signal Name
2	GR	-

Connector No.	B113
Connector Name	AIR BAG DIAGNOSIS SENSOR UNIT
Connector Color	YELLOW

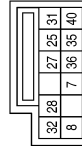

Terminal No.	Color of Wire	Signal Name
25	L	RH BUCKLE SW INPUT

Connector No.	B116
Connector Name	REAR DOOR SWITCH RH
Connector Color	WHITE

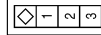

Terminal No.	Color of Wire	Signal Name
2	B	-



A
B
C
D
E
F
G
H
I
J
K
L
M
O
P

WCS

COMBINATION METER

< ECU DIAGNOSIS >

Connector No.	B202
Connector Name	SEAT BELT BUCKLE SWITCH LH
Connector Color	WHITE

Terminal No.	Color of Wire	Signal Name
1	L	-
2	B	-

Connector No.	B201
Connector Name	WIRE TO WIRE
Connector Color	WHITE

Terminal No.	Color of Wire	Signal Name
1	L	-
8	B	-

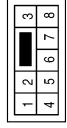
Connector No.	B148
Connector Name	WIRE TO WIRE
Connector Color	WHITE

Terminal No.	Color of Wire	Signal Name
1	L	-
8	B	-

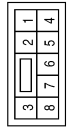
Connector No.	T2
Connector Name	WIRE TO WIRE
Connector Color	WHITE

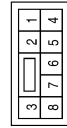

Terminal No.	Color of Wire	Signal Name
5	W	-
6	V	-
8	B	-

Connector No.	B308
Connector Name	WIRE TO WIRE
Connector Color	WHITE

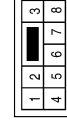
Terminal No.	Color of Wire	Signal Name
1	L	-
8	B	-

Connector No.	B302
Connector Name	SEAT BELT BUCKLE SWITCH RH
Connector Color	WHITE

Terminal No.	Color of Wire	Signal Name
1	L	SIGNAL
2	B	GND

ABNIA0427GB

COMBINATION METER

< ECU DIAGNOSIS >

A
B
C
D
E
F
G
H
I
J
K
L
M
N
O
P

Connector No.	T7
Connector Name	TRUNK LAMP SWITCH AND TRUNK RELEASE SOLENOID
Connector Color	WHITE

Terminal No.	Color of Wire	Signal Name
1	B	-
2	W	-
3	B	-
4	V	-



WCS

Fail Safe

The combination meter performs a fail-safe operation for the functions listed below when communication is lost.

ABNIA0428GB

INFOID:000000005511899

COMBINATION METER

< ECU DIAGNOSIS >

Function		Specifications
Speedometer		Zero indication.
Tachometer		
Fuel gauge		
Engine coolant temperature gauge		
Illumination control	Meter illumination	Change to nighttime mode when communication is lost.
Segment LCD	Odometer	Freeze current indication.
	CVT position	Display turns off.
Buzzer		Buzzer turns off.
Warning lamp/indicator lamp	ABS warning lamp	Lamp turns on when communication is lost.
	Brake warning lamp	
	TCS/VDC OFF indicator lamp	
	SLIP indicator lamp	
	Malfunction indicator lamp	Lamp turns off when communication is lost.
	CVT warning lamp	
	Oil pressure warning lamp	
	Master warning lamp	
	Air bag warning lamp	
	High beam indicator	
	Turn signal indicator lamp	
	CRUISE indicator lamp	Lamp turns off when disconnected.
	Intelligent Key system warning lamp	
	Driver and passenger seat belt warning lamp	
Charge warning lamp	Lamp turns off when disconnected.	
Security indicator lamp		
Low tire pressure warning lamp	Lamp will flash every second for 1 minute and then stay on continuously thereafter.	

DTC Index

INFOID:00000000511900

CONSULT-III display	Malfunction	Reference page
CAN COMM CIRCUIT [U1000]	When combination meter is not transmitting or receiving CAN communication signal for 2 seconds or more.	MWI-32
CONTROL UNIT (CAN) [U1010]	When detecting error during the initial diagnosis of the CAN controller of combination meter.	MWI-33
VEHICLE SPEED [B2205]	The abnormal vehicle speed signal is input from the ABS actuator and electric unit (control unit) for 2 seconds or more.	MWI-34
ENGINE SPEED [B2267]	If ECM continuously transmits abnormal engine speed signals for 2 seconds or more.	MWI-35
WATER TEMP [B2268]	If ECM continuously transmits abnormal engine coolant temperature signals for 60 seconds or more.	MWI-36

NOTE:

“TIME” indicates the following.

- 0: Indicates that a malfunction is detected at present.
- 1-63: Indicates that a malfunction was detected in the past. (Displays number of ignition switch OFF → ON cycles after malfunction is detected. Self-diagnosis result is erased when “63” is exceeded.)

BCM (BODY CONTROL MODULE)

< ECU DIAGNOSIS >

BCM (BODY CONTROL MODULE)

Reference Value

INFOID:000000005511901

VALUES ON THE DIAGNOSIS TOOL

Monitor Item	Condition	Value/Status
FR WIPER HI	Other than front wiper switch HI	OFF
	Front wiper switch HI	ON
FR WIPER LOW	Other than front wiper switch LO	OFF
	Front wiper switch LO	ON
FR WASHER SW	Front washer switch OFF	OFF
	Front washer switch ON	ON
FR WIPER INT	Other than front wiper switch INT	OFF
	Front wiper switch INT	ON
FR WIPER STOP	Front wiper is not in STOP position	OFF
	Front wiper is in STOP position	ON
INT VOLUME	Wiper intermittent dial is in a dial position 1 - 7	Wiper intermittent dial position
TURN SIGNAL R	Other than turn signal switch RH	OFF
	Turn signal switch RH	ON
TURN SIGNAL L	Other than turn signal switch LH	OFF
	Turn signal switch LH	ON
TAIL LAMP SW	Other than lighting switch 1ST and 2ND	OFF
	Lighting switch 1ST or 2ND	ON
HI BEAM SW	Other than lighting switch HI	OFF
	Lighting switch HI	ON
HEAD LAMP SW 1	Other than lighting switch 2ND	OFF
	Lighting switch 2ND	ON
HEAD LAMP SW 2	Other than lighting switch 2ND	OFF
	Lighting switch 2ND	ON
PASSING SW	Other than lighting switch PASS	OFF
	Lighting switch PASS	ON
AUTO LIGHT SW	Other than lighting switch AUTO	OFF
	Lighting switch AUTO	ON
FR FOG SW	Front fog lamp switch OFF	OFF
	Front fog lamp switch ON	ON
DOOR SW-DR	Driver door closed	OFF
	Driver door opened	ON
DOOR SW-AS	Passenger door closed	OFF
	Passenger door opened	ON
DOOR SW-RR	Rear door RH closed	OFF
	Rear door RH opened	ON
DOOR SW-RL	Rear door LH closed	OFF
	Rear door LH opened	ON
CDL LOCK SW	Other than power door lock switch LOCK	OFF
	Power door lock switch LOCK	ON

A

B

C

D

E

F

G

H

I

J

K

L

M

WCS

O

P

BCM (BODY CONTROL MODULE)

< ECU DIAGNOSIS >

Monitor Item	Condition	Value/Status
CDL UNLOCK SW	Other than power door lock switch UNLOCK	OFF
	Power door lock switch UNLOCK	ON
KEY CYL LK-SW	Other than driver door key cylinder LOCK position	OFF
	Driver door key cylinder LOCK position	ON
KEY CYL UN-SW	Other than driver door key cylinder UNLOCK position	OFF
	Driver door key cylinder UNLOCK position	ON
HAZARD SW	When hazard switch is not pressed	OFF
	When hazard switch is pressed	ON
REAR DEF SW	When rear window defogger switch is pressed	ON
TR CANCEL SW	Trunk lid opener cancel switch OFF	OFF
	Trunk lid opener cancel switch ON	ON
TR/BD OPEN SW	Trunk lid opener switch OFF	OFF
	While the trunk lid opener switch is turned ON	ON
TRNK/HAT MNTR	Trunk lid closed	OFF
	Trunk lid opened	ON
RKE-LOCK	When LOCK button of Intelligent Key is not pressed	OFF
	When LOCK button of Intelligent Key is pressed	ON
RKE-UNLOCK	When UNLOCK button of Intelligent Key is not pressed	OFF
	When UNLOCK button of Intelligent Key is pressed	ON
RKE-TR/BD	When TRUNK OPEN button of Intelligent Key is not pressed	OFF
	When TRUNK OPEN button of Intelligent Key is pressed	ON
RKE-PANIC	When PANIC button of Intelligent Key is not pressed	OFF
	When PANIC button of Intelligent Key is pressed	ON
RKE-P/W OPEN	When UNLOCK button of Intelligent Key is not pressed and held	OFF
	When UNLOCK button of Intelligent Key is pressed and held	ON
RKE-MODE CHG	When LOCK/UNLOCK button of Intelligent Key is not pressed and held simultaneously	OFF
	When LOCK/UNLOCK button of Intelligent Key is pressed and held simultaneously	ON
OPTICAL SENSOR	When outside of the vehicle is bright	Close to 5 V
	When outside of the vehicle is dark	Close to 0 V
REQ SW-DR	When front door request switch is not pressed (driver side)	OFF
	When front door request switch is pressed (driver side)	ON
REQ SW-AS	When front door request switch is not pressed (passenger side)	OFF
	When front door request switch is pressed (passenger side)	ON
REQ SW-RL	When rear door request switch is not pressed (driver side)	OFF
	When rear door request switch is pressed (driver side)	ON
REQ SW-RR	When rear door request switch is not pressed (passenger side)	OFF
	When rear door request switch is pressed (passenger side)	ON
REQ SW-BD/TR	When trunk request switch is not pressed	OFF
	When trunk request switch is pressed	ON
PUSH SW	When engine switch (push switch) is not pressed	OFF
	When engine switch (push switch) is pressed	ON
IGN RLY 2-F/B	Ignition switch OFF or ACC	OFF
	Ignition switch ON	ON

BCM (BODY CONTROL MODULE)

< ECU DIAGNOSIS >

Monitor Item	Condition	Value/Status	
ACC RLY-F/B	Ignition switch OFF	OFF	A
	Ignition switch ACC or ON	ON	
BRAKE SW 1	When the brake pedal is not depressed	ON	B
	When the brake pedal is depressed	OFF	
DETE/CANCL SW	When selector lever is in P position	OFF	C
	When selector lever is in any position other than P	ON	
SFT PN/N SW	When selector lever is in any position other than P or N	OFF	D
	When selector lever is in P or N position	ON	
S/L-LOCK*	Electronic steering column lock LOCK status	OFF	E
	Electronic steering column lock UNLOCK status	ON	
S/L-UNLOCK*	Electronic steering column lock UNLOCK status	OFF	F
	Electronic steering column lock LOCK status	ON	
S/L RELAY-F/B*	Ignition switch OFF or ACC	OFF	G
	Ignition switch ON	ON	
UNLK SEN-DR	Driver door UNLOCK status	OFF	H
	Driver door LOCK status	ON	
PUSH SW-IPDM	When engine switch (push switch) is not pressed	OFF	I
	When engine switch (push switch) is pressed	ON	
IGN RLY1 F/B	Ignition switch OFF or ACC	OFF	J
	Ignition switch ON	ON	
DETE SW -IPDM	When selector lever is in P position	OFF	K
	When selector lever is in any position other than P	ON	
SFT PN -IPDM	When selector lever is in any position other than P or N	OFF	L
	When selector lever is in P or N position	ON	
SFT P-MET	When selector lever is in any position other than P	OFF	M
	When selector lever is in P position	ON	
SFT N-MET	When selector lever is in any position other than N	OFF	
	When selector lever is in N position	ON	
ENGINE STATE	Engine stopped	STOP	
	While the engine stalls	STALL	
	At engine cranking	CRANK	
	Engine running	RUN	
S/L LOCK-IPDM*	Electronic steering column lock LOCK status	OFF	WCS
	Electronic steering column lock UNLOCK status	ON	
S/L UNLK-IPDM*	Electronic steering column lock UNLOCK status	OFF	O
	Electronic steering column lock LOCK status	ON	
S/L RELAY-REQ*	Ignition switch OFF or ACC	OFF	P
	Ignition switch ON	ON	
VEH SPEED 1	While driving	Equivalent to speedometer reading	
VEH SPEED 2	While driving	Equivalent to speedometer reading	
DOOR STAT-DR	Driver door LOCK status	LOCK	
	Wait with selective UNLOCK operation (5 seconds)	READY	
	Driver door UNLOCK status	UNLK	

BCM (BODY CONTROL MODULE)

< ECU DIAGNOSIS >

Monitor Item	Condition	Value/Status
DOOR STAT-AS	Passenger door LOCK status	LOCK
	Wait with selective UNLOCK operation (5 seconds)	READY
	Passenger door UNLOCK status	UNLK
ID OK FLAG	Ignition switch ACC or ON	RESET
	Ignition switch OFF	SET
PRMT ENG STRT	When the engine start is prohibited	RESET
	When the engine start is permitted	SET
KEY SW -SLOT	When Intelligent Key is not inserted into key slot	OFF
	When Intelligent Key is inserted into key slot	ON
RKE OPE COUN1	During the operation of Intelligent Key	Operation frequency of Intelligent Key
CONFIRM ID ALL	The key ID that the key slot receives does not accord with any key ID registered to BCM.	YET
	The key ID that the key slot receives accords with any key ID registered to BCM.	DONE
CONFIRM ID4	The key ID that the key slot receives does not accord with the fourth key ID registered to BCM.	YET
	The key ID that the key slot receives accords with the fourth key ID registered to BCM.	DONE
CONFIRM ID3	The key ID that the key slot receives does not accord with the third key ID registered to BCM.	YET
	The key ID that the key slot receives accords with the third key ID registered to BCM.	DONE
CONFIRM ID2	The key ID that the key slot receives does not accord with the second key ID registered to BCM.	YET
	The key ID that the key slot receives accords with the second key ID registered to BCM.	DONE
CONFIRM ID1	The key ID that the key slot receives does not accord with the first key ID registered to BCM.	YET
	The key ID that the key slot receives accords with the first key ID registered to BCM.	DONE
TP 4	The ID of fourth key is not registered to BCM	YET
	The ID of fourth key is registered to BCM	DONE
TP 3	The ID of third key is not registered to BCM	YET
	The ID of third key is registered to BCM	DONE
TP 2	The ID of second key is not registered to BCM	YET
	The ID of second key is registered to BCM	DONE
TP 1	The ID of first key is not registered to BCM	YET
	The ID of first key is registered to BCM	DONE
AIR PRESS FL	Ignition switch ON (only when the signal from the transmitter is received)	Air pressure of front LH tire
AIR PRESS FR	Ignition switch ON (only when the signal from the transmitter is received)	Air pressure of front RH tire
AIR PRESS RR	Ignition switch ON (only when the signal from the transmitter is received)	Air pressure of rear RH tire
AIR PRESS RL	Ignition switch ON (only when the signal from the transmitter is received)	Air pressure of rear LH tire
ID REGST FL1	When ID of front LH tire transmitter is registered	DONE
	When ID of front LH tire transmitter is not registered	YET

BCM (BODY CONTROL MODULE)

< ECU DIAGNOSIS >

Monitor Item	Condition	Value/Status	
ID REGST FR1	When ID of front RH tire transmitter is registered	DONE	A
	When ID of front RH tire transmitter is not registered	YET	
ID REGST RR1	When ID of rear RH tire transmitter is registered	DONE	B
	When ID of rear RH tire transmitter is not registered	YET	
ID REGST RL1	When ID of rear LH tire transmitter is registered	DONE	C
	When ID of rear LH tire transmitter is not registered	YET	
WARNING LAMP	Tire pressure indicator OFF	OFF	
	Tire pressure indicator ON	ON	D
BUZZER	Tire pressure warning alarm is not sounding	OFF	
	Tire pressure warning alarm is sounding	ON	E

* : With electronic steering column lock

A
B
C
D
E
F
G
H
I
J
K
L
M
O
P

WCS

BCM (BODY CONTROL MODULE)

< ECU DIAGNOSIS >

Terminal Layout

INFOID:000000005511902

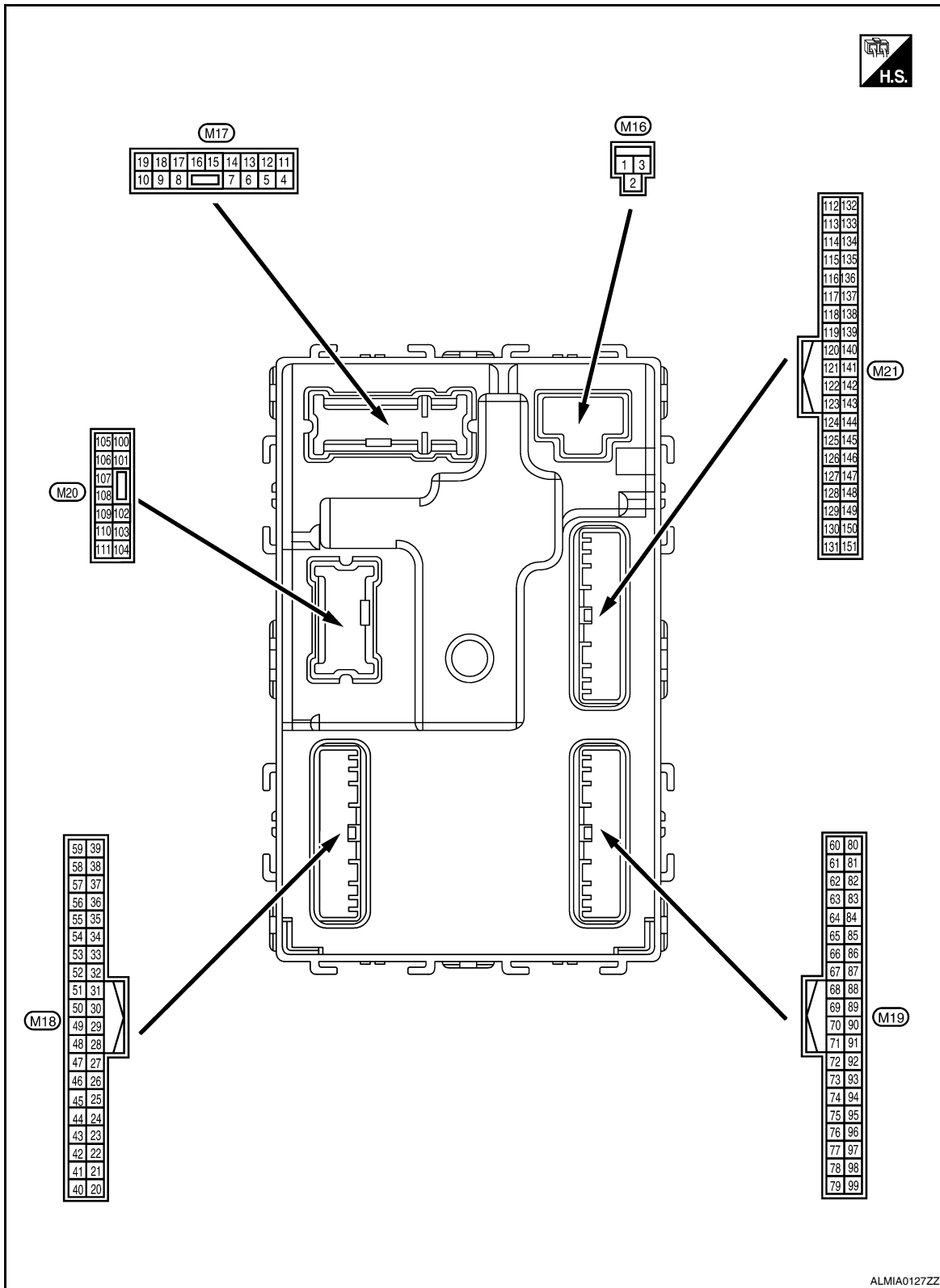

Physical Values

INFOID:000000005511903

BCM (BODY CONTROL MODULE)

< ECU DIAGNOSIS >

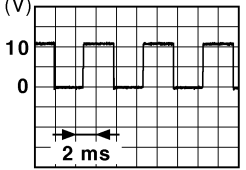
Terminal No. (Wire color)		Description		Condition		Value (Approx.)
(+)	(-)	Signal name	Input/ Output			
1 (W/B)	Ground	Battery power supply	Input	Ignition switch OFF		Battery voltage
2 (R/Y)	Ground	Battery power supply output	Output	Ignition switch OFF		Battery voltage
3 (L/W)	Ground	Ignition power supply output	Output	Ignition switch ON		Battery voltage
4 (P/W)	Ground	Interior room lamp power supply	Output	After passing the interior room lamp battery saver operation time		0V
				Any other time after passing the interior room lamp battery saver operation time		Battery voltage
5 (G)	Ground	Front door RH UNLOCK	Output	Front door RH	UNLOCK (actuator is activated)	Battery voltage
					Other than UNLOCK (actuator is not activated)	0V
7 (R/W)	Ground	Step lamp	Output	Step lamp	ON	0V
					OFF	Battery voltage
8 (V)	Ground	All doors LOCK	Output	All doors	LOCK (actuator is activated)	Battery voltage
					Other than LOCK (actuator is not activated)	0V
9 (L)	Ground	Front door LH UNLOCK	Output	Front door LH	UNLOCK (actuator is activated)	Battery voltage
					Other than UNLOCK (actuator is not activated)	0V
10 (G)	Ground	Rear door RH and rear door LH UNLOCK	Output	Rear door RH and rear door LH	UNLOCK (actuator is activated)	Battery voltage
					Other than UNLOCK (actuator is not activated)	0V
11 (Y/R)	Ground	Battery power supply	Input	Ignition switch OFF		Battery voltage
13 (B)	Ground	Ground	—	Ignition switch ON		0V
14 (GR/W)	Ground	Engine switch (push switch) illumination ground	Input	Tail lamp	OFF	0V
					ON	<p>NOTE: When the illumination brightening/dimming level is in the neutral position</p>  <p style="text-align: right; font-size: small;">JSNIA0010GB</p>
15 (Y/L)	Ground	ACC indicator lamp	Output	Ignition switch	OFF	Battery voltage
					ACC or ON	0V

A
B
C
D
E
F
G
H
I
J
K
L
M
O
P

WCS

BCM (BODY CONTROL MODULE)

< ECU DIAGNOSIS >

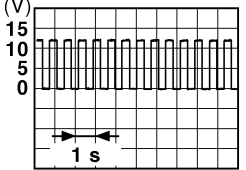
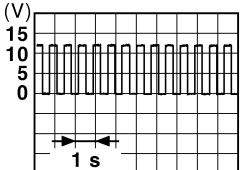
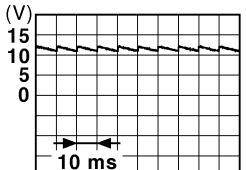
Terminal No. (Wire color)		Description		Condition	Value (Approx.)
(+)	(-)	Signal name	Input/ Output		
17 (G/B)	Ground	Turn signal (RH)	Output	Ignition switch ON	Turn signal switch OFF 0V
				Turn signal switch RH	 6.5 V
18 (G/Y)	Ground	Turn signal (LH)	Output	Ignition switch ON	Turn signal switch OFF 0V
				Turn signal switch LH	 6.5 V
19 (Y)	Ground	Room lamp timer control	Output	Interior room lamp	OFF Battery voltage
				ON	0V
21 (P/B)	Ground	Optical sensor signal	Input	Ignition switch ON	When outside of the vehicle is bright Close to 5V
				When outside of the vehicle is dark Close to 0V	
24 (R/W)	Ground	Stop lamp switch 1	Input	—	Battery voltage
26 (O/L)	Ground	Stop lamp switch 2	Input	Stop lamp switch	OFF (brake pedal is released) 0V
				ON (brake pedal is depressed) Battery voltage	
27 (O)	Ground	Front door lock assembly LH (unlock sensor)	Input	Front door LH	LOCK status  11.8V
				UNLOCK status 0V	
29 (Y)	Ground	Key slot switch	Input	When Intelligent Key is inserted into key slot Battery voltage	
				When Intelligent Key is not inserted into key slot 0V	
30 (V/Y)	Ground	ACC feedback signal	Input	Ignition switch	OFF 0
				ACC or ON Battery voltage	
31 (G)	Ground	Rear window defogger feedback signal	Input	Rear window defogger switch	OFF 0V
				ON Battery voltage	

BCM (BODY CONTROL MODULE)



< ECU DIAGNOSIS >

Terminal No. (Wire color)		Description		Condition		Value (Approx.)
(+)	(-)	Signal name	Input/ Output			
32 (R/B)	Ground	Front door RH switch	Input	Front door RH switch	OFF (when front door RH closes)	<p style="text-align: right; font-size: small;">JPMIA0011GB</p> <p style="text-align: center;">11.8 V</p>
					ON (when front door RH opens)	0V
37 (O)	Ground	Trunk lid opener cancel switch	Input	Trunk lid opener cancel switch	CANCEL	<p style="text-align: right; font-size: small;">JPMIA0012GB</p> <p style="text-align: center;">1.1V</p>
					ON	0V
38 (GR/W)	Ground	Rear window defogger ON signal	Input	Rear window defogger switch	OFF	5V
					ON	0V
40 (Y/G)	Ground	Power window serial link	Input/ Output	Ignition switch ON	<p style="text-align: right; font-size: small;">JPMIA0013GB</p> <p style="text-align: center;">10.2V</p>	
				Ignition switch OFF or ACC	0V	
41 (W)	Ground	Engine switch (push switch) illumination	Output	Engine switch (push switch) illumination	ON	5.5V
				OFF	0V	
42 (R)	Ground	LOCK indicator lamp	Output	LOCK indicator lamp	ON	0V
				OFF	Battery voltage	
45 (P)	Ground	Receiver & sensor ground	Input	Ignition switch ON	0V	WCS
46 (V/W)	Ground	Receiver & sensor power supply output	Output	Ignition switch	OFF	
					ACC or ON	5.0V

A
B
C
D
E
F
G
H
I
J
K
L
M
O
P

BCM (BODY CONTROL MODULE)

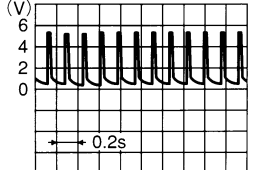
< ECU DIAGNOSIS >

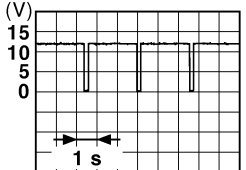
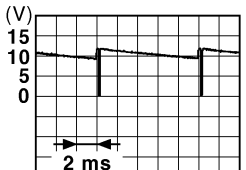
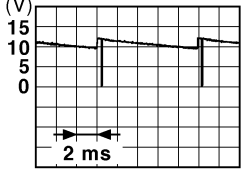
Terminal No. (Wire color)		Description		Condition	Value (Approx.)
(+)	(-)	Signal name	Input/ Output		
47 ¹ (G/O)	Ground	Tire pressure receiver signal	Input/ Output	Ignition switch ON	Standby state  OCC3881D
				When receiving the signal from the transmitter  OCC3880D	
48 (R/G)	Ground	Selector lever transmission range switch signal	Input	Selector lever	P or N position 12.0V Except P and N positions 0V
					ON 0V
49 (L/O)	Ground	Security indicator signal	Output	Security indicator	Blinking  JPMIA0014GB 11.3V
					OFF Battery voltage
50 (LG/B)	Ground	Combination switch OUTPUT 5	Output	Combination switch (Wiper intermittent dial 4)	All switch OFF 0V Lighting switch 1ST Lighting switch high-beam Lighting switch 2ND Turn signal switch RH  JPMIA0031GB 10.7V
51 (L/W)	Ground	Combination switch OUTPUT 1	Output	Combination switch	All switch OFF (Wiper intermittent dial 4) 0V Front wiper switch HI (Wiper intermittent dial 4) Any of the conditions below with all switch OFF • Wiper intermittent dial 1 • Wiper intermittent dial 2 • Wiper intermittent dial 3 • Wiper intermittent dial 6 • Wiper intermittent dial 7  JPMIA0032GB 10.7V

BCM (BODY CONTROL MODULE)

< ECU DIAGNOSIS >

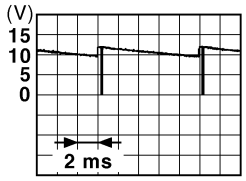
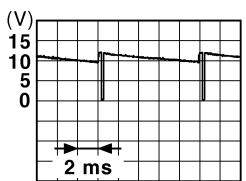
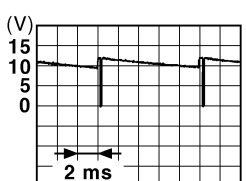
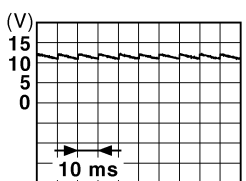
Terminal No. (Wire color)		Description		Condition	Value (Approx.)		
(+)	(-)	Signal name	Input/ Output				
52 (G/B)	Ground	Combination switch OUTPUT 2	Output	Combination switch	All switch OFF (Wiper intermittent dial 4)	0V	
					Front washer switch ON (Wiper intermittent dial 4)		
					Any of the conditions below with all switch OFF		
					<ul style="list-style-type: none"> • Wiper intermittent dial 1 • Wiper intermittent dial 5 • Wiper intermittent dial 6 		
					10.7V		
53 (LG/ R)	Ground	Combination switch OUTPUT 3	Output	Combination switch (Wiper intermit- tent dial 4)	All switch OFF	0V	
					Front wiper switch INT		
					Front wiper switch LO		
					Lighting switch AUTO		
					10.7V		
54 (G/Y)	Ground	Combination switch OUTPUT 4	Output	Combination switch (Wiper intermit- tent dial 4)	All switch OFF	0V	
					Front fog lamp switch ON		
					Lighting switch 2ND		
					Lighting switch flash-to- pass		
					10.7V		
57 ¹ (W)	Ground	Tire pressure warn- ing check switch	Input	—	5V		
58 (SB)	Ground	Front door LH switch	Input	Front door LH switch	OFF (front door LH CLOSE)		
					ON (front door LH OPEN)	0V	
59 (G/R)	Ground	Rear window defog- ger relay	Output	Rear window de- fogger	Active	Battery voltage	
					Not activated	0V	

A
B
C
D
E
F
G
H
I
J
K
L
M
O
P

WCS

BCM (BODY CONTROL MODULE)

< ECU DIAGNOSIS >

Terminal No. (Wire color)		Description		Condition	Value (Approx.)
(+)	(-)	Signal name	Input/ Output		
60 (B/R)	Ground	Front console antenna 2 (-)	Output	Ignition switch OFF	<p style="text-align: right; font-size: small;">JMKIA0062GB</p>
				When Intelligent Key is not in the passenger compartment	<p style="text-align: right; font-size: small;">JMKIA0063GB</p>
61 (W/R)	Ground	Center console antenna 2 (+)	Output	Ignition switch OFF	<p style="text-align: right; font-size: small;">JMKIA0062GB</p>
				When Intelligent Key is not in the passenger compartment	<p style="text-align: right; font-size: small;">JMKIA0063GB</p>
62 (V)	Ground	Front outside handle RH antenna (-)	Output	When the front door RH request switch is operated with ignition switch OFF	<p style="text-align: right; font-size: small;">JMKIA0062GB</p>
				When Intelligent Key is not in the antenna detection area	<p style="text-align: right; font-size: small;">JMKIA0063GB</p>

BCM (BODY CONTROL MODULE)

< ECU DIAGNOSIS >

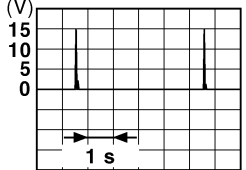
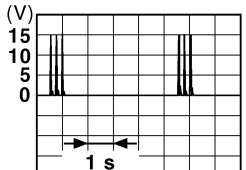
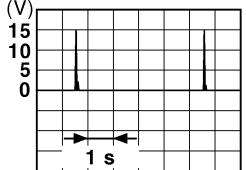
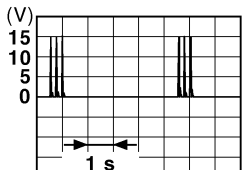
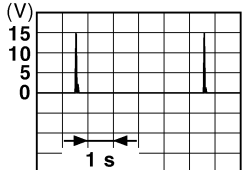
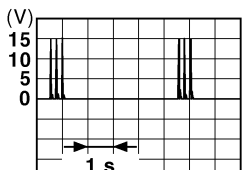



Terminal No. (Wire color)		Description		Condition	Value (Approx.)
		Signal name	Input/ Output		
(+)	(-)				
63 (P)	Ground	Front outside handle RH antenna (+)	Output	When the front door RH request switch is operated with ignition switch OFF	 <p style="text-align: right; font-size: small;">JMKIA0062GB</p>
				When Intelligent Key is not in the antenna detection area	 <p style="text-align: right; font-size: small;">JMKIA0063GB</p>
64 (V)	Ground	Front outside handle LH antenna (-)	Output	When the front door LH request switch is operated with ignition switch OFF	 <p style="text-align: right; font-size: small;">JMKIA0062GB</p>
				When Intelligent Key is not in the antenna detection area	 <p style="text-align: right; font-size: small;">JMKIA0063GB</p>
65 (P)	Ground	Front outside handle LH antenna (+)	Output	When the front door LH request switch is operated with ignition switch OFF	 <p style="text-align: right; font-size: small;">JMKIA0062GB</p>
				When Intelligent Key is not in the antenna detection area	 <p style="text-align: right; font-size: small;">JMKIA0063GB</p>

A
B
C
D
E
F
G
H
I
J
K
L
M
O
P

WCS

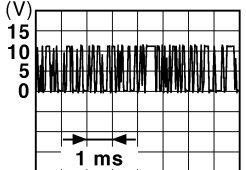
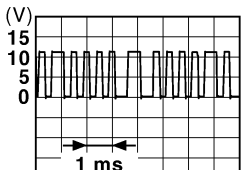

BCM (BODY CONTROL MODULE)

< ECU DIAGNOSIS >

Terminal No. (Wire color)		Description		Condition		Value (Approx.)
(+)	(-)	Signal name	Input/ Output			
68 (G/O)	Ground	NATS antenna amp (built in key slot)	Input/ Output	During waiting	Ignition switch is pressed while inserting the Intelli- gent Key into the key slot.	Just after pressing ignition switch. Pointer of tester should move.
69 (O)	Ground	NATS antenna amp (built in key slot)	Input/ Output	During waiting	Ignition switch is pressed while inserting the Intelli- gent Key into the key slot.	Just after pressing ignition switch. Pointer of tester should move.
70 (R/B)	Ground	Ignition relay-2 con- trol	Output	Ignition switch	OFF or ACC ON	0V Battery voltage
71 (L/O)	Ground	Remote keyless entry receiver signal	Input/ Output	During waiting		 <p style="text-align: right; font-size: small;">JMKIA0064GB</p>
				When operating either button on Intelligent Key		 <p style="text-align: right; font-size: small;">JMKIA0065GB</p>
75 (R/Y)	Ground	Combination switch INPUT 5	Input	Combination switch	All switch OFF (Wiper intermittent dial 4)	 <p style="text-align: right; font-size: small;">JPMIA0041GB</p> <p style="text-align: center;">1.4V</p>
					Front fog lamp switch ON (Wiper intermittent dial 4)	 <p style="text-align: right; font-size: small;">JPMIA0037GB</p> <p style="text-align: center;">1.3V</p>
					Any of the conditions below with all switch OFF • Wiper intermittent dial 1 • Wiper intermittent dial 2 • Wiper intermittent dial 6 • Wiper intermittent dial 7	 <p style="text-align: right; font-size: small;">JPMIA0040GB</p> <p style="text-align: center;">1.3V</p>

BCM (BODY CONTROL MODULE)

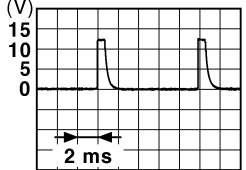
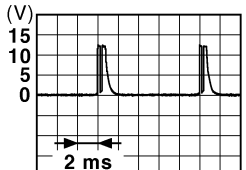
< ECU DIAGNOSIS >

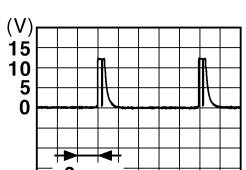
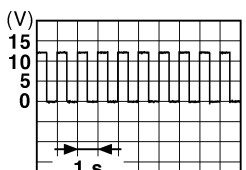
Terminal No. (Wire color)		Description		Condition	Value (Approx.)	
(+)	(-)	Signal name	Input/ Output			
76 (R/G)	Ground	Combination switch INPUT 3	Input	Combination switch	All switch OFF (Wiper intermittent dial 4)	 <small>JPMIA0041GB</small> 1.4V
					Lighting switch high-beam (Wiper intermittent dial 4)	 <small>JPMIA0036GB</small> 1.3V
					Lighting switch 2ND (Wiper intermittent dial 4)	 <small>JPMIA0037GB</small> 1.3V
					Any of the conditions below with all switch OFF • Wiper intermittent dial 1 • Wiper intermittent dial 2 • Wiper intermittent dial 3	 <small>JPMIA0040GB</small> 1.3V
77 ² (BR)	Ground	Engine switch (push switch)	Input	Engine switch (push switch)	Pressed	0V
					Not pressed	Battery voltage
78 (P)	Ground	CAN-L	Input/ Output	—	—	
79 (L)	Ground	CAN-H	Input/ Output	—	—	
80 (R/L)	Ground	Key slot illumination	Output	Key slot illumina- tion	OFF	0V
					Blinking	 <small>JPMIA0015GB</small> 6.5V
					ON	Battery voltage

A
B
C
D
E
F
G
H
I
J
K
L
M
O
P

WCS



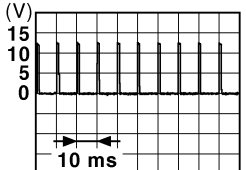
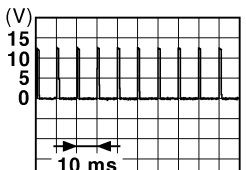

BCM (BODY CONTROL MODULE)

< ECU DIAGNOSIS >

Terminal No. (Wire color)		Description		Condition		Value (Approx.)
(+)	(-)	Signal name	Input/ Output			
81 (LG)	Ground	ON indicator lamp	Output	Ignition switch	OFF or ACC	0V
					ON	Battery voltage
83 (L)	Ground	ACC relay control	Output	Ignition switch	OFF	0V
					ACC or ON	Battery voltage
84 (Y/R)	Ground	CVT shift selector	Output	—		Battery voltage
85 ³ (L/O)	Ground	Electronic steering column lock condition No. 1	Input	Electronic steer- ing column lock	Lock status	0V
					Unlock status	Battery voltage
86 ³ (G/R)	Ground	Electronic steering column lock condition No. 2	Input	Electronic steer- ing column lock	Lock status	Battery voltage
					Unlock status	0V
87 (G/B)	Ground	Selector lever P posi- tion switch	Input	Selector lever	P position	0V
					Any position other than P	Battery voltage
88 (R)	Ground	Front door RH re- quest switch	Input	Front door RH re- quest switch	ON (pressed)	0V
					OFF (not pressed)	
89 (R)	Ground	Front door LH re- quest switch	Input	Front door LH re- quest switch	ON (pressed)	0V
					OFF (not pressed)	
90 (Y)	Ground	Blower fan motor re- lay control	Output	Ignition switch	OFF or ACC	0V
					ON	Battery voltage
91 (L/R)	Ground	Remote keyless entry receiver power sup- ply	Output	Ignition switch OFF		Battery voltage
94 ³ (G/Y)	Ground	Steering wheel lock unit power supply	Output	Ignition switch	OFF or ACC	Battery voltage
					ON	0V

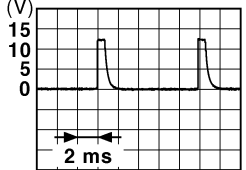
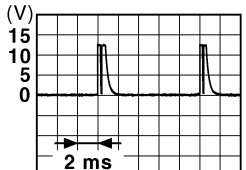
BCM (BODY CONTROL MODULE)

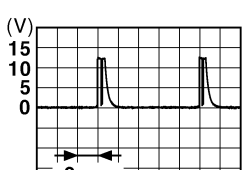
< ECU DIAGNOSIS >

Terminal No. (Wire color)		Description		Condition	Value (Approx.)
(+)	(-)	Signal name	Input/ Output		
95 (R/W)	Ground	Combination switch INPUT 1	Input	Combination switch (Wiper intermittent dial 4)	All switch OFF  1.4V
					Turn signal switch LH  1.3V
					Turn signal switch RH  1.3V
					Front wiper switch LO  1.3V
					Front washer switch ON  1.3V

A
B
C
D
E
F
G
H
I
J
K
L
M
O
P

WCS



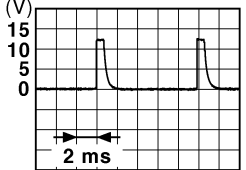
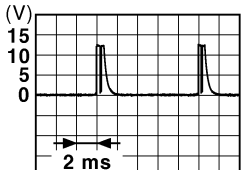
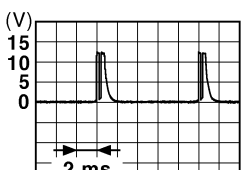
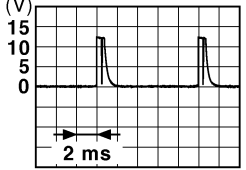

BCM (BODY CONTROL MODULE)

< ECU DIAGNOSIS >

Terminal No. (Wire color)		Description		Condition	Value (Approx.)
(+)	(-)	Signal name	Input/ Output		
96 (P/B)	Ground	Combination switch INPUT 4	Input	Combination switch	All switch OFF (Wiper intermittent dial 4)  <p style="text-align: right; font-size: small;">JPMIA0041GB</p> <p style="text-align: center;">1.4V</p>
					Lighting switch AUTO (Wiper intermittent dial 4)  <p style="text-align: right; font-size: small;">JPMIA0038GB</p> <p style="text-align: center;">1.3V</p>
					Lighting switch 1ST (Wiper intermittent dial 4)  <p style="text-align: right; font-size: small;">JPMIA0036GB</p> <p style="text-align: center;">1.3V</p>
					Any of the conditions below with all switch OFF <ul style="list-style-type: none"> • Wiper intermittent dial 1 • Wiper intermittent dial 5 • Wiper intermittent dial 6  <p style="text-align: right; font-size: small;">JPMIA0039GB</p> <p style="text-align: center;">1.3V</p>

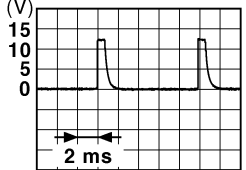
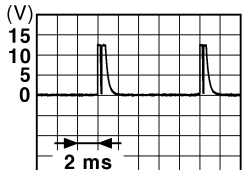
BCM (BODY CONTROL MODULE)

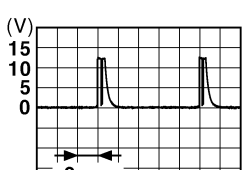
< ECU DIAGNOSIS >

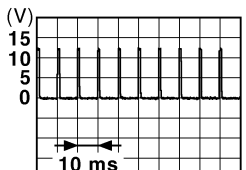
Terminal No. (Wire color)		Description		Condition	Value (Approx.)	
(+)	(-)	Signal name	Input/ Output			
97 (R/B)	Ground	Combination switch INPUT 2	Input	Combination switch (Wiper intermittent dial 4)	All switch OFF	 <p style="text-align: right;">1.4V</p>
					Lighting switch flash-to-pass	 <p style="text-align: right;">1.3V</p>
					Lighting switch 2ND	 <p style="text-align: right;">1.3V</p>
					Front wiper switch INT	 <p style="text-align: right;">1.3V</p>
					Front wiper switch HI	 <p style="text-align: right;">1.3V</p>
					Pressed	0 V
98 (G/O)	Ground	Hazard switch	Input	Hazard switch	Not pressed	 <p style="text-align: right;">1.1V</p>

A
B
C
D
E
F
G
H
I
J
K
L
M
O
P

WCS

BCM (BODY CONTROL MODULE)

< ECU DIAGNOSIS >

Terminal No. (Wire color)		Description		Condition	Value (Approx.)	
(+)	(-)	Signal name	Input/ Output			
99 ³ (L/Y)	Ground	Electronic steering column lock unit com- munication	Input/ Output	Electronic steer- ing column lock	LOCK status	Battery voltage
					LOCK or UNLOCK	<p style="text-align: right; font-size: small;">JMKIA0066GB</p>
					For 15 seconds after UN- LOCK	Battery voltage
					15 seconds or later after UNLOCK	0V
103 (V)	Ground	Trunk lid opening.	Output	Trunk lid	Open (trunk lid opener ac- tuator is activated)	Battery voltage
					Close (trunk lid opener ac- tuator is not activated)	0V
110 (V/W)	Ground	Trunk room lamp	Output	Trunk room lamp	ON	0V
					OFF	Battery voltage
114 (B)	Ground	Trunk room antenna 1 (-)	Output	Ignition switch OFF	When Intelligent Key is in the passenger compart- ment	<p style="text-align: right; font-size: small;">JMKIA0062GB</p>
					When Intelligent Key is not in the passenger compart- ment	<p style="text-align: right; font-size: small;">JMKIA0063GB</p>

BCM (BODY CONTROL MODULE)

< ECU DIAGNOSIS >

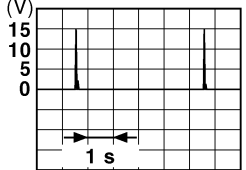
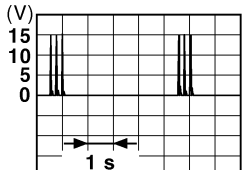
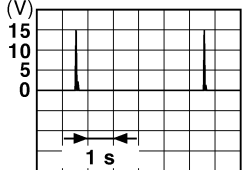
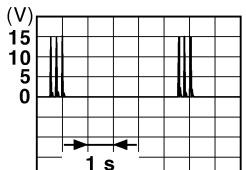
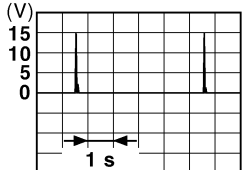
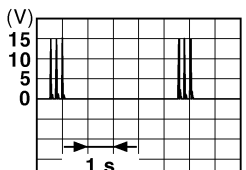
Terminal No. (Wire color)		Description		Condition	Value (Approx.)
(+)	(-)	Signal name	Input/ Output		
115 (W)	Ground	Trunk room antenna 1 (+)	Output	Ignition switch OFF	 <p style="text-align: right; font-size: small;">JMKIA0062GB</p>
				When Intelligent Key is not in the passenger compart- ment	 <p style="text-align: right; font-size: small;">JMKIA0063GB</p>
118 (L/O)	Ground	Rear bumper anten- na (-)	Output	When the trunk lid request switch is operated with ignition switch OFF	 <p style="text-align: right; font-size: small;">JMKIA0062GB</p>
				When Intelligent Key is not in the antenna detection area	 <p style="text-align: right; font-size: small;">JMKIA0063GB</p>
119 (BR/ W)	Ground	Rear bumper anten- na (+)	Output	When the trunk lid request switch is operated with ignition switch OFF	 <p style="text-align: right; font-size: small;">JMKIA0062GB</p>
				When Intelligent Key is not in the antenna detection area	 <p style="text-align: right; font-size: small;">JMKIA0063GB</p>

A
B
C
D
E
F
G
H
I
J
K
L
M
O
P

WCS

BCM (BODY CONTROL MODULE)

< ECU DIAGNOSIS >

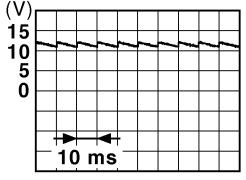
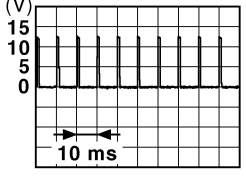
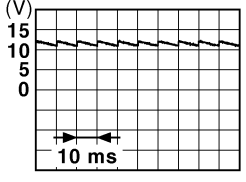
Terminal No. (Wire color)		Description		Condition		Value (Approx.)
(+)	(-)	Signal name	Input/ Output			
127 (BR/ W)	Ground	Ignition relay (IPDM E/R) control	Output	Ignition switch	OFF or ACC	Battery voltage
					ON	0V
130 (W)	Ground	Trunk room lamp switch	Input	Trunk room lamp switch	OFF (trunk is closed)	 <p style="text-align: right; margin-right: 50px;">JPMIA0011GB</p> <p style="text-align: center;">11.8V</p>
					ON (trunk is open)	0V
132 (R)	Ground	Starter motor relay control	Output	Ignition switch ON	When selector lever is in P or N position and the brake is depressed	Battery voltage
					When selector lever is in P or N position and the brake is not depressed	0V
140 ⁴ (L/R)	Ground	Engine switch (push switch)	Input	Engine switch (push switch)	Pressed	0V
					Not pressed	Battery voltage
141 (BR)	Ground	Trunk request switch	Input	Trunk request switch	ON (pressed)	0V
					OFF (not pressed)	 <p style="text-align: right; margin-right: 50px;">JPMIA0016GB</p> <p style="text-align: center;">1.0V</p>
144 (GR)	Ground	Request switch buzz- er	Output	Request switch buzzer	Sounding	0V
					Not sounding	Battery voltage
147 (L/R)	Ground	Trunk lid opener switch	Input	Trunk lid opener switch	Pressed	0V
					Not pressed	Battery voltage
148 (R/W)	Ground	Rear door RH switch	Input	Rear door RH switch	OFF (when rear door RH closes)	 <p style="text-align: right; margin-right: 50px;">JPMIA0011GB</p> <p style="text-align: center;">11.8V</p>
					ON (when rear door RH opens)	0V

BCM (BODY CONTROL MODULE)

< ECU DIAGNOSIS >

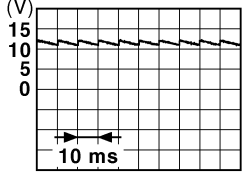
Terminal No. (Wire color)		Description		Condition	Value (Approx.)	
		Signal name	Input/ Output			
(+)	(-)					
149 (R/B)	Ground	Rear door LH switch	Input	Rear door LH switch	OFF (when rear door LH closes)	
				ON (when rear door LH opens)	0V	

- 1 : With low tire pressure monitoring system
- 2 : With electronic steering column lock
- 3 : Early production
- 4 : Without electronic steering column lock

A
B
C
D
E
F
G
H
I
J
K
L
M
O
P

WCS

BCM (BODY CONTROL MODULE)

< ECU DIAGNOSIS >

Wiring Diagram

INFOID:000000005511904

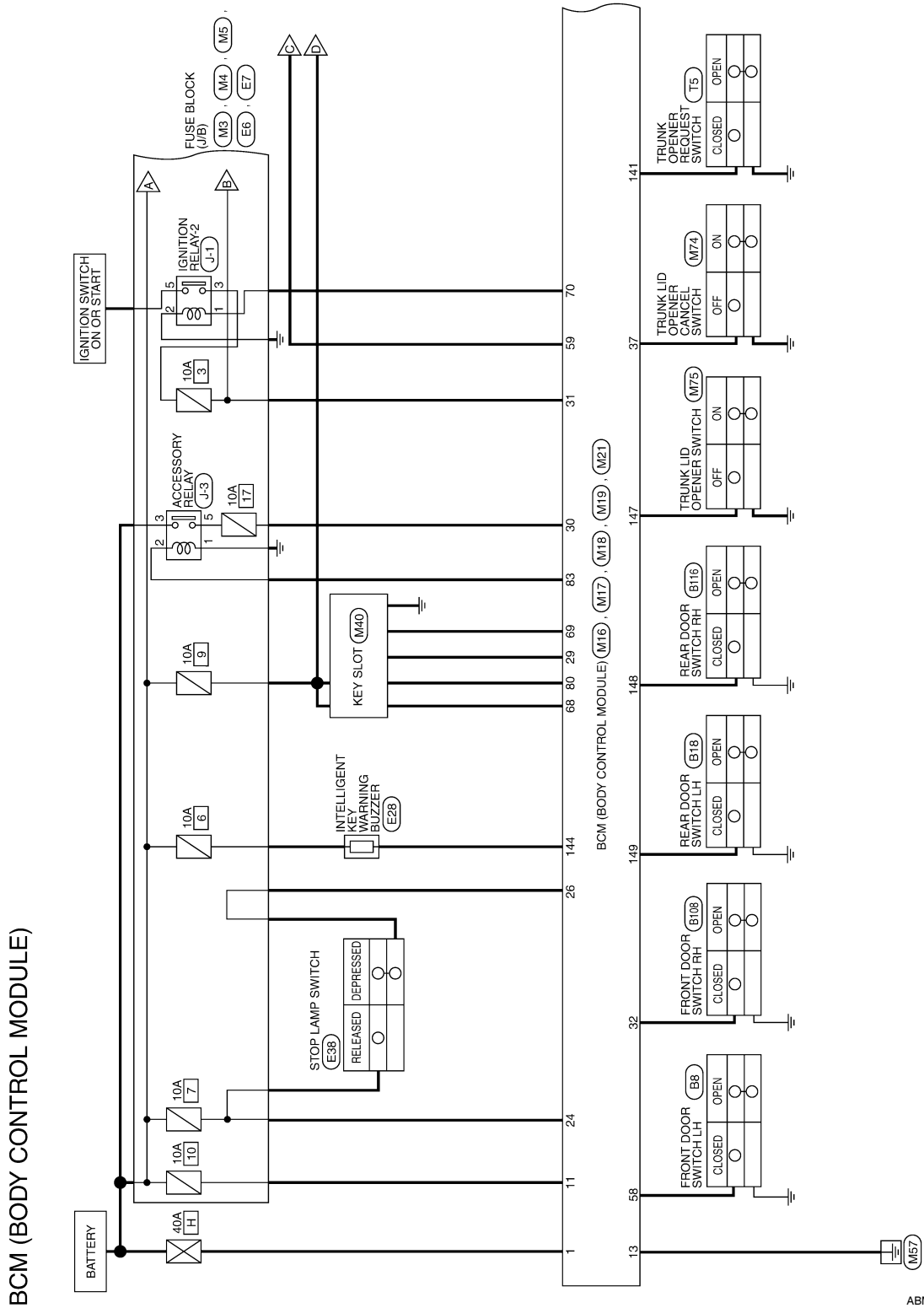

ABMWA0498G

BCM (BODY CONTROL MODULE)

< ECU DIAGNOSIS >

- ◊TP◊ : WITH LOW TIRE PRESSURE MONITORING SYSTEM
- ◊EH◊ : WITH ELECTRONIC STEERING COLUMN LOCK
- ◊EJ◊ : WITHOUT ELECTRONIC STEERING COLUMN LOCK

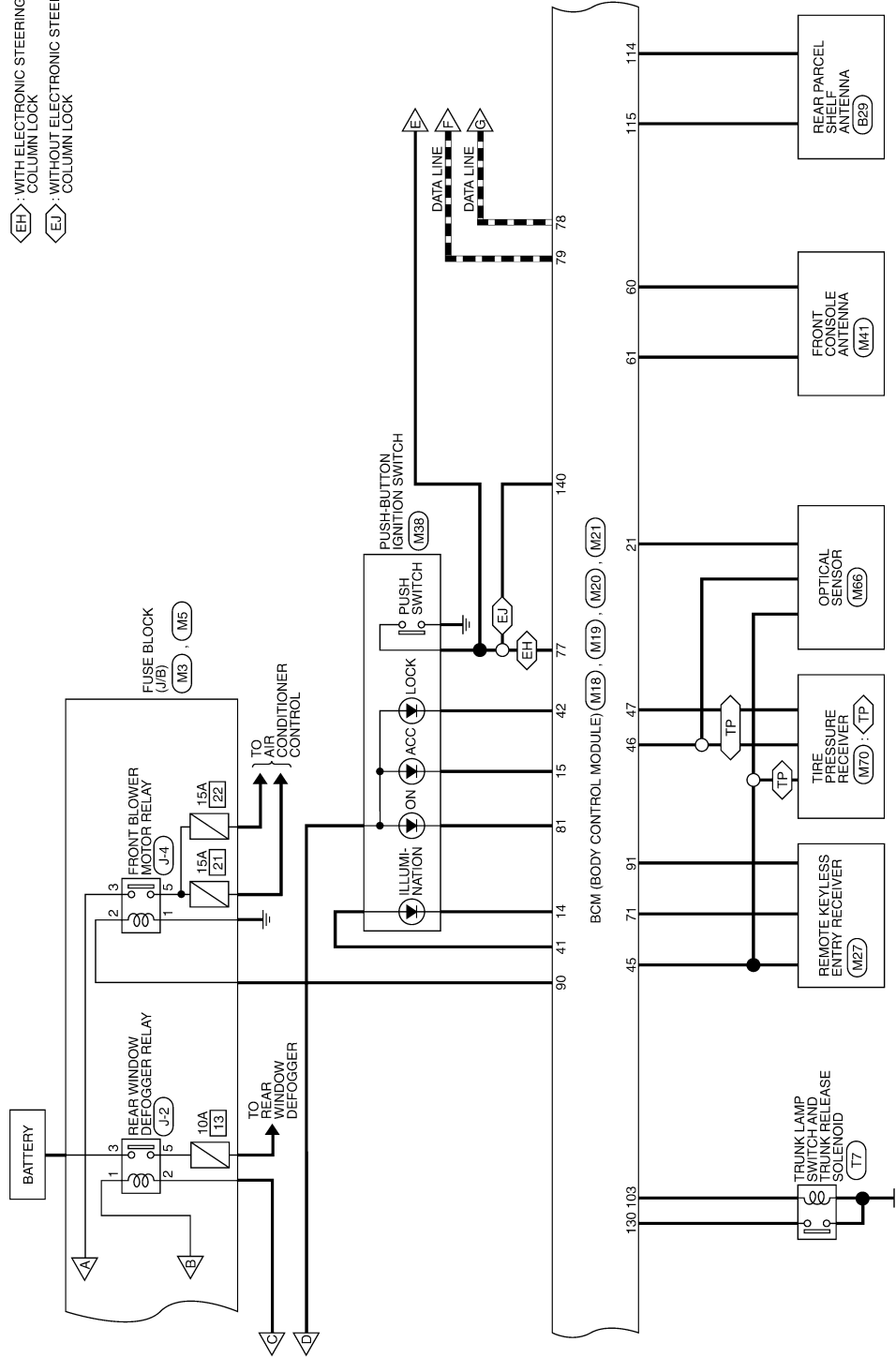

A
B
C
D
E
F
G
H
I
J
K
L
M
N
O
P

WCS

ABMWA0817GI

BCM (BODY CONTROL MODULE)

< ECU DIAGNOSIS >

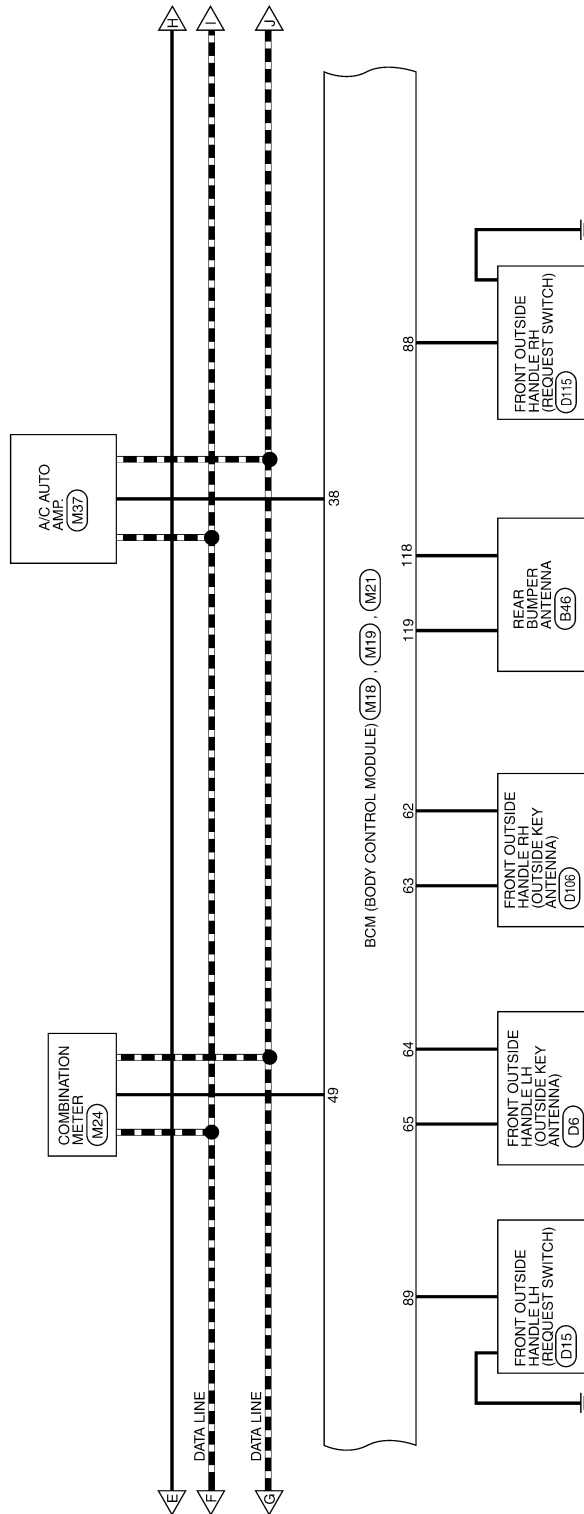

ABMWA0818GI

BCM (BODY CONTROL MODULE)

< ECU DIAGNOSIS >

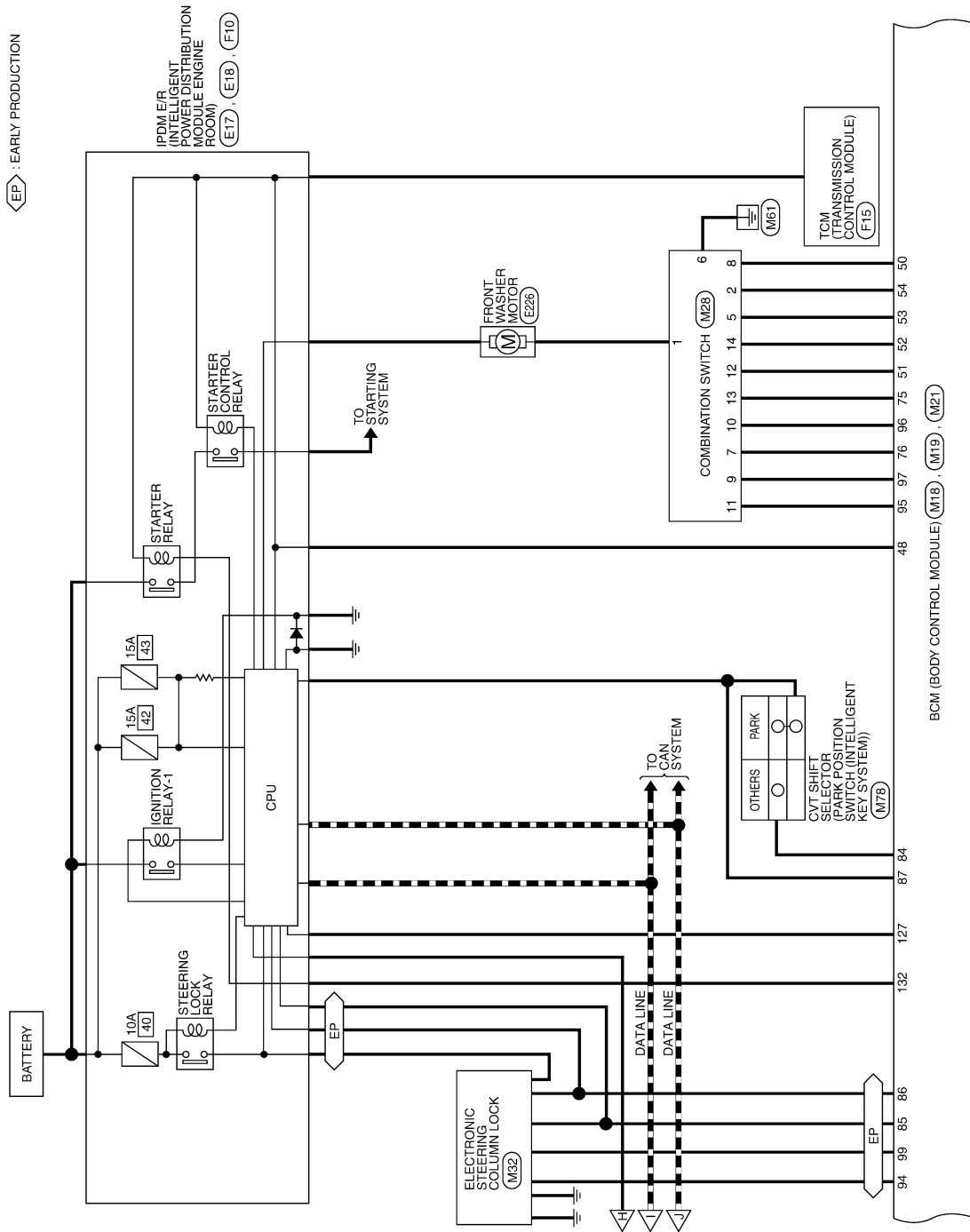

A
B
C
D
E
F
G
H
I
J
K
L
M
N
O
P

WCS

ABMWA0819GI

BCM (BODY CONTROL MODULE)

< ECU DIAGNOSIS >

- $\langle A2 \rangle$: WITH LEFT AND RIGHT FRONT POWER WINDOW ANTI-PINCH SYSTEM
- $\langle A3 \rangle$: WITH FRONT AND REAR POWER WINDOW ANTI-PINCH SYSTEM
- $\langle DP \rangle$: WITH DUAL PANEL SUNROOF
- $\langle DW \rangle$: WITHOUT DUAL PANEL SUNROOF

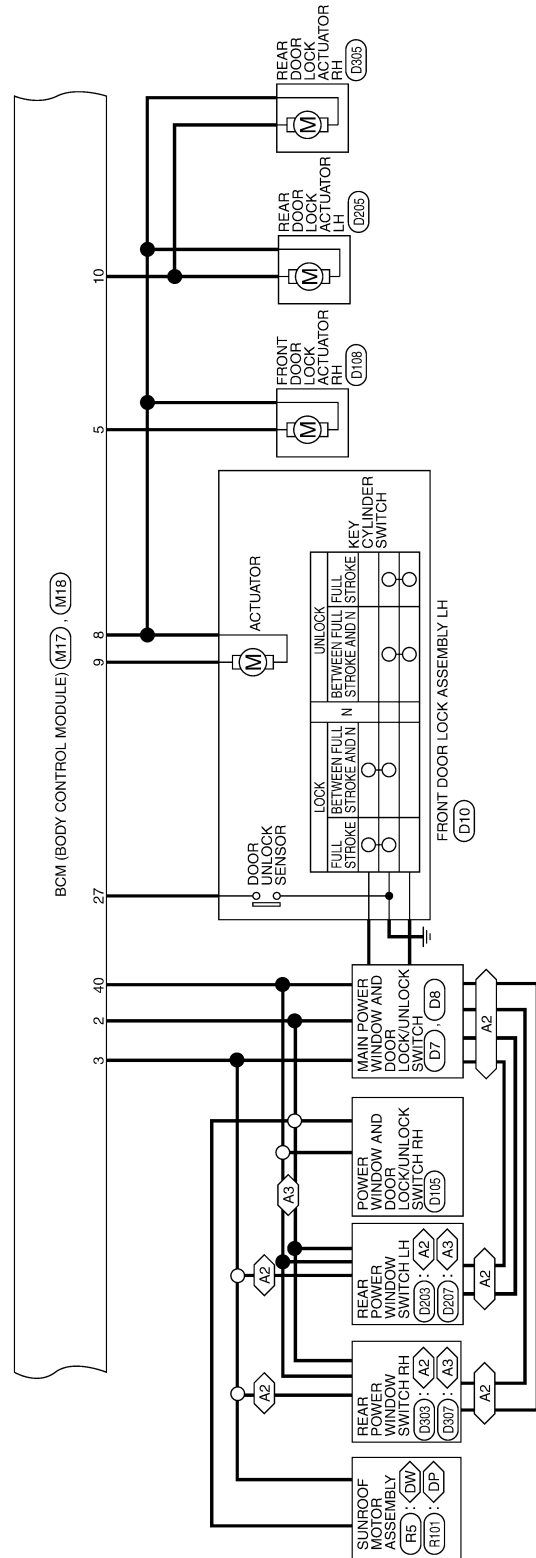

ABMWA0081GI

BCM (BODY CONTROL MODULE)

< ECU DIAGNOSIS >

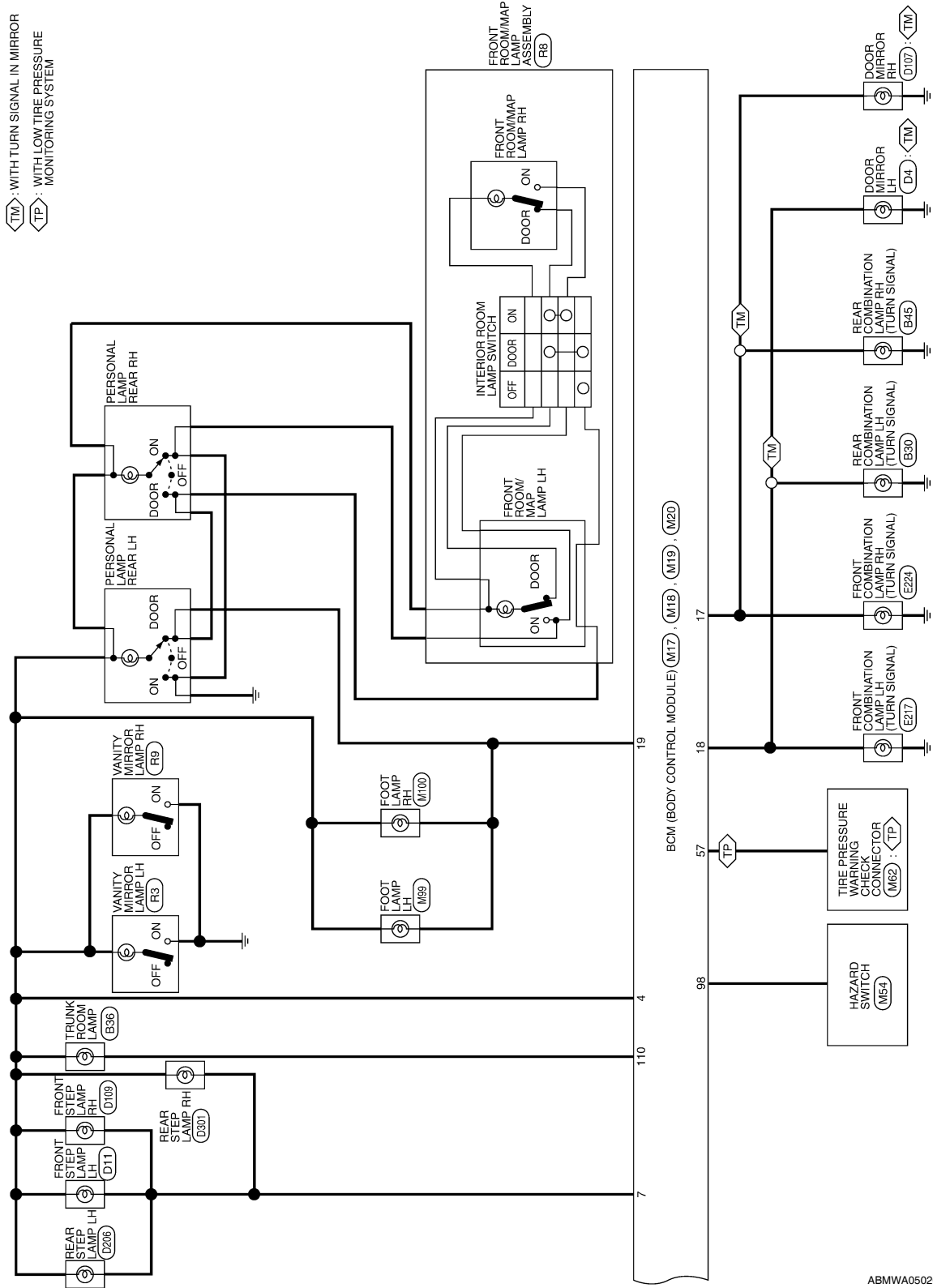

A
B
C
D
E
F
G
H
I
J
K
L
M
O
P

WCS

BCM (BODY CONTROL MODULE)

< ECU DIAGNOSIS >

BCM (BODY CONTROL MODULE) CONNECTORS

Connector No.	M16
Connector Name	BCM (BODY CONTROL MODULE)
Connector Color	BLACK



Terminal No.	Color of Wire	Signal Name
1	W/B	BATT (F/L)
2	R/Y	P/W POWER SUPPLY PERM
3	L/W	P/W POWER SUPPLY IGN

Connector No.	M17
Connector Name	BCM (BODY CONTROL MODULE)
Connector Color	WHITE

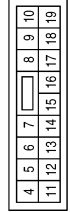

Terminal No.	Color of Wire	Signal Name
4	P/W	R/L POWER SUPPLY
5	G	DOOR UNLOCK OUTPUT AS
6	-	-
7	R/W	STEP LAMP CONT
8	V	DOOR LOCK OUTPUT ALL
9	L	DOOR UNLOCK OUTPUT (DR/FL)

Terminal No.	Color of Wire	Signal Name
10	G	DOOR UNLOCK OUTPUT (RR/RL)
11	Y/R	BAT BCM FUSE
12	-	-
13	B	GND1
14	GR/W	LOW SIDE PUSH LED
15	Y/L	ACC LED
16	-	-
17	G/B	FR FLASHER
18	G/Y	FL FLASHER
19	Y	ROOM LAMP CONT

Connector No.	M18
Connector Name	BCM (BODY CONTROL MODULE)
Connector Color	GREEN

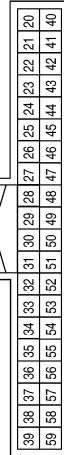

Terminal No.	Color of Wire	Signal Name
20	-	-
21	P/B	A/L SIGNAL TYPE 1
22	-	-
23	-	-
24	R/W	BRAKE SW1
25	-	-
26	O/L	BRAKE SW2

Terminal No.	Color of Wire	Signal Name
27	O	DOOR LOCK STATUS DR
28	-	-
29	Y	FOB IN SW 1
30	V/Y	ACC F/B
31	G	IGN F/B
32	R/B	AS DOOR SW 1
33	-	-
34	-	-
35	-	-
36	-	-
37	O	TRUNK CANCEL SW
38	GR/W	REAR DEFOGGER SW
39	-	-
40	Y/G	PW K-LINE
41	W	RING LED
42	R	S/L LOCK LED
43	-	-
44	-	-

Terminal No.	Color of Wire	Signal Name
45	P	GND RF2 A/L
46	V/W	A/L POWER SUPPLY 5V
47	G/O	RF2 TUNER SIGNAL
48	R/G	SHIFT N/P/NEUTRAL SW
49	L/O	IMMO LED (SECURITY INDICATOR)
50	LG/B	OUTPUT 5
51	L/W	OUTPUT 1
52	G/B	OUTPUT 2
53	LG/R	OUTPUT 3
54	G/Y	OUTPUT 4
55	-	-
56	-	-
57	W	TPMS MODE
58	SB	DR DOOR SW
59	G/R	REAR DEFOGGER

ABMIA1331GB

BCM (BODY CONTROL MODULE)

< ECU DIAGNOSIS >

Connector No.	M19
Connector Name	BCM (BODY CONTROL MODULE)
Connector Color	BLACK



79	78	77	76	75	74	73	72	71	70	69	68	67	66	65	64	63	62	61	60
----	----	----	----	----	----	----	----	----	----	----	----	----	----	----	----	----	----	----	----

Terminal No.	Color of Wire	Signal Name
60	B/R	ROOM ANT 2 B
61	W/R	ROOM ANT 2 A
62	V	AS DOOR ANT B
63	P	AS DOOR ANT A
64	V	DR DOOR ANT B
65	P	DR DOOR ANT A
66	-	-

Connector No.	M20
Connector Name	BCM (BODY CONTROL MODULE)
Connector Color	WHITE



100	101	102	103	104
105	106	107	108	109
110	111			

Terminal No.	Color of Wire	Signal Name
100	-	-
101	-	-
102	-	-
103	V	CDL BACK TRUNK

Terminal No.	Color of Wire	Signal Name
67	-	-
68	G/O	FOB READER CLOCK
69	O	FOB READER DATA
70	R/B	IGN REL OUTPUT 2
71	L/O	RF1 TUNER SIGNAL
72	-	-
73	-	-
74	-	-
75	R/Y	INPUT 5
76	R/G	INPUT 3
77	BR	ENG START SW
78	P	CAN-L
79	L	CAN-H
80	R/L	FOB SLOT ILLUMINATION
81	LG	IGN ON LED
82	-	-
83	L	ACC CONT

Terminal No.	Color of Wire	Signal Name
84	Y/R	AT DEVICE OUT
85	L/O	S/L CONDITION 1
86	G/R	S/L CONDITION 2
87	G/B	SHIFT P/ASCD CANCEL SW
88	R	AS REQUEST SW
89	R	DR REQUEST SW
90	Y	BLOWER FAN RELAY
91	L/R	RF POWER SUPPLY 12V
92	-	-
93	-	-
94	G/Y	S/L POWER SUPPLY 12V
95	R/W	INPUT 1
96	P/B	INPUT 4
97	R/B	INPUT 2
98	G/O	HAZARD SW
99	L/Y	S/L K-LINE

Terminal No.	Color of Wire	Signal Name
104	-	-
105	-	-
106	-	-
107	-	-
108	-	-
109	-	-
110	V/W	TRUNK LAMP CONT
111	-	-

A
B
C
D
E
F
G
H
I
J
K
L
M
N
O
P

BCM (BODY CONTROL MODULE)

< ECU DIAGNOSIS >

Terminal No.	Color of Wire	Signal Name
136	-	-
137	-	-
138	-	-
139	-	-
140	BR	ENG START SW W/O ESCL
141	BR	TRUNK REQUEST SW
142	-	-
143	-	-
144	GR	BUZZER
145	-	-
146	-	-
147	L/R	BACK TRUNK OPENER
148	R/W	RR DOOR SW
149	R/B	RL DOOR SW
150	-	-
151	-	-

Terminal No.	Color of Wire	Signal Name
119	BR/W	BACK DOOR ANT A
120	-	-
121	-	-
122	-	-
123	-	-
124	-	-
125	-	-
126	-	-
127	BR/W	IGN RELAY OUTPUT
128	-	-
129	-	-
130	W	TRUNK SW
131	-	-
132	R	ST RELAY OUTPUT
133	-	-
134	-	-
135	-	-

Terminal No.	Color of Wire	Signal Name
10	P/B	INPUT 4
11	R/W	INPUT 1
12	L/W	OUTPUT 1
13	R/Y	INPUT 5
14	G/B	OUTPUT 2

Connector No.	M21
Connector Name	BCM (BODY CONTROL MODULE)
Connector Color	GRAY

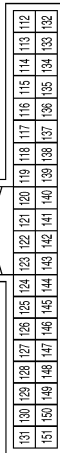

Terminal No.	Color of Wire	Signal Name
112	-	-
113	-	-
114	B	TRUNK ANT 1 B
115	W	TRUNK ANT 1 A
116	-	-
117	-	-
118	L/O	BACK DOOR ANT B

Connector No.	M28
Connector Name	COMBINATION SWITCH
Connector Color	WHITE

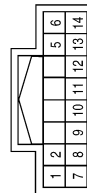

Terminal No.	Color of Wire	Signal Name
1	R/L	-
2	G/Y	OUTPUT 4
5	LG/R	OUTPUT 3
6	B	-
7	R/G	INPUT 3
8	LG/B	OUTPUT 5
9	R/B	INPUT 2

ABMIA2102GB

INFOID:000000005511905

Fail Safe

Display contents of CONSULT	Fail-safe	Cancellation
B2013: ID DISCORD BCM-S/L*	Inhibit engine cranking	Erase DTC
B2014: CHAIN OF S/L-BCM*	Inhibit engine cranking	Erase DTC
B2190: NATS ANTENNA AMP	Inhibit engine cranking	Erase DTC

BCM (BODY CONTROL MODULE)

< ECU DIAGNOSIS >

Display contents of CONSULT	Fail-safe	Cancellation	
B2191: DIFFERENCE OF KEY	Inhibit engine cranking	Erase DTC	A
B2192: ID DISCORD BCM-ECM	Inhibit engine cranking	Erase DTC	
B2193: CHAIN OF BCM-ECM	Inhibit engine cranking	Erase DTC	B
B2195: ANTI-SCANNING	Inhibit engine cranking	Erase DTC	
B2557: VEHICLE SPEED*	Inhibit electronic steering column lock	When normal vehicle speed signals have been received from ABS actuator and electric unit (control unit) for 500 ms	C
B2560: STARTER CONT RELAY	Inhibit engine cranking	500 ms after the following CAN signal communication status has become consistent <ul style="list-style-type: none"> • Starter control relay signal • Starter relay status signal 	D
B2562: LO VOLTAGE	<ul style="list-style-type: none"> • Inhibit engine cranking • Inhibit electronic steering column lock* 	100 ms after the power supply voltage increases to more than 8.8 V	E
B2601: SHIFT POSITION*	Inhibit electronic steering column lock	500 ms after the following signal reception status becomes consistent <ul style="list-style-type: none"> • Selector lever P position switch signal • P range signal (CAN) 	F
B2602: SHIFT POSITION*	Inhibit electronic steering column lock	5 seconds after the following BCM recognition conditions are fulfilled <ul style="list-style-type: none"> • Ignition switch is in the ON position • Selector lever P position switch signal: Except P position (battery voltage) • Vehicle speed: 4 km/h or more 	G
B2603: SHIFT POSI STATUS*	Inhibit electronic steering column lock	500 ms after the following BCM recognition conditions are fulfilled <ul style="list-style-type: none"> • Ignition switch is in the ON position • Selector lever P position switch signal: Except P position (battery voltage) • Selector lever transmission range switch signal: Except P and N positions (0 V) 	H
B2604: TRANSMISSION RANGE SWITCH*	Inhibit electronic steering column lock	500 ms after any of the following BCM recognition conditions is fulfilled <ul style="list-style-type: none"> • Status 1 <ul style="list-style-type: none"> - Ignition switch is in the ON position - Selector lever transmission range switch signal: P and N position (battery voltage) - P range signal or N range signal (CAN): ON • Status 2 <ul style="list-style-type: none"> - Ignition switch is in the ON position - Selector lever transmission range switch signal: Except P and N positions (0 V) - P range signal and N range signal (CAN): OFF 	I
B2605: TRANSMISSION RANGE SWITCH*	Inhibit electronic steering column lock	500 ms after any of the following BCM recognition conditions is fulfilled <ul style="list-style-type: none"> • Ignition switch is in the ON position - Power position: IGN - Selector lever transmission range switch signal: Except P and N positions (0 V) - Transmission range switch signal (CAN): OFF • Status 2 <ul style="list-style-type: none"> - Ignition switch is in the ON position - Selector lever transmission range switch signal: P or N position (battery voltage) - Transmission range switch signal (CAN): ON 	J
B2606: S/L RELAY*	Inhibit engine cranking	500 ms after the following CAN signal communication status has become consistent <ul style="list-style-type: none"> • Electronic steering column lock relay signal (Request signal) • Electronic steering column lock relay signal (Condition signal) 	K

WCS

BCM (BODY CONTROL MODULE)

< ECU DIAGNOSIS >

Display contents of CONSULT	Fail-safe	Cancellation
B2607: S/L RELAY*	Inhibit engine cranking	500 ms after the following CAN signal communication status has become consistent <ul style="list-style-type: none"> Electronic steering column lock relay signal (Request signal) Electronic steering column lock relay signal (Condition signal)
B2608: STARTER RELAY	Inhibit engine cranking	500 ms after the following signal communication status becomes consistent <ul style="list-style-type: none"> Starter motor relay control signal Starter relay status signal (CAN)
B2609: S/L STATUS*	<ul style="list-style-type: none"> Inhibit engine cranking Inhibit electronic steering column lock 	When the following electronic steering column lock conditions agree <ul style="list-style-type: none"> BCM electronic steering column lock control status Electronic steering column lock condition No. 1 signal status Electronic steering column lock condition No. 2 signal status
B260A: IGNITION RELAY	Inhibit engine cranking	500 ms after the following conditions are fulfilled <ul style="list-style-type: none"> IGN relay (IPDM E/R) control signal: OFF (Battery voltage) Ignition ON signal (CAN to IPDM E/R): OFF (Request signal) Ignition ON signal (CAN from IPDM E/R): OFF (Condition signal)
B260F: ENG STATE SIG LOST	Maintains the power supply position attained at the time of DTC detection	When any of the following conditions is fulfilled <ul style="list-style-type: none"> Power position changes to ACC Receives engine status signal (CAN)
B2612: S/L STATUS*	<ul style="list-style-type: none"> Inhibit engine cranking Inhibit electronic steering column lock 	When any of the following conditions is fulfilled <ul style="list-style-type: none"> Electronic steering column lock unit status signal (CAN) is received normally The BCM electronic steering column lock control status matches the electronic steering column lock status recognized by the electronic steering column lock unit status signal (CAN from IPDM E/R)
B2617: STARTER RELAY CIRC	Inhibit engine cranking	1 second after the starter motor relay control inside BCM becomes normal
B2618: BCM	Inhibit engine cranking	1 second after the ignition relay (IPDM E/R) control inside BCM becomes normal
B2619: BCM*	Inhibit engine cranking	1 second after the electronic steering column lock unit power supply output control inside BCM becomes normal
B26E1: ENG STATE NO RECIV	Inhibit engine cranking	When any of the following conditions are fulfilled <ul style="list-style-type: none"> Power position changes to ACC Receives engine status signal (CAN)

* : With electronic steering column lock

DTC Inspection Priority Chart

INFOID:000000005511906

If some DTCs are displayed at the same time, perform inspections one by one based on the following priority chart.

Priority	DTC
1	<ul style="list-style-type: none"> B2562: LO VOLTAGE
2	<ul style="list-style-type: none"> U1000: CAN COMM CIRCUIT U1010: CONTROL UNIT (CAN)
3	<ul style="list-style-type: none"> B2190: NATS ANTENNA AMP B2191: DIFFERENCE OF KEY B2192: ID DISCORD BCM-ECM B2193: CHAIN OF BCM-ECM

BCM (BODY CONTROL MODULE)

< ECU DIAGNOSIS >

Priority	DTC	A
4	<ul style="list-style-type: none"> • B2013: ID DISCORD BCM-S/L* • B2014: CHAIN OF S/L-BCM* • B2553: IGNITION RELAY • B2555: STOP LAMP • B2556: PUSH-BTN IGN SW • B2557: VEHICLE SPEED • B2560: STARTER CONT RELAY • B2601: SHIFT POSITION • B2602: SHIFT POSITION • B2603: SHIFT POSI STATUS • B2604: TRANSMISSION RANGE SWITCH • B2605: TRANSMISSION RANGE SWITCH • B2606: S/L RELAY* • B2607: S/L RELAY* • B2608: STARTER RELAY • B2609: S/L STATUS* • B260A: IGNITION RELAY • B260B: STEERING LOCK UNIT* • B260C: STEERING LOCK UNIT* • B260D: STEERING LOCK UNIT* • B260F: ENG STATE SIG LOST • B2612: S/L STATUS* • B2614: ACC RELAY CIRC • B2615: BLOWER RELAY CIRC • B2616: IGN RELAY CIRC • B2617: STARTER RELAY CIRC • B2618: BCM • B2619: BCM* • B261A: PUSH-BTN IGN SW • B26E1: ENG STATE NO RECIV • C1729: VHCL SPEED SIG ERR • U0415: VEHICLE SPEED SIG 	A B C D E F G H I J
	<ul style="list-style-type: none"> • C1704: LOW PRESSURE FL • C1705: LOW PRESSURE FR • C1706: LOW PRESSURE RR • C1707: LOW PRESSURE RL • C1708: [NO DATA] FL • C1709: [NO DATA] FR • C1710: [NO DATA] RR • C1711: [NO DATA] RL • C1712: [CHECKSUM ERR] FL • C1713: [CHECKSUM ERR] FR • C1714: [CHECKSUM ERR] RR • C1715: [CHECKSUM ERR] RL • C1716: [PRESSDATA ERR] FL • C1717: [PRESSDATA ERR] FR • C1718: [PRESSDATA ERR] RR • C1719: [PRESSDATA ERR] RL • C1720: [CODE ERR] FL • C1721: [CODE ERR] FR • C1722: [CODE ERR] RR • C1723: [CODE ERR] RL • C1724: [BATT VOLT LOW] FL • C1725: [BATT VOLT LOW] FR • C1726: [BATT VOLT LOW] RR • C1727: [BATT VOLT LOW] RL • C1734: CONTROL UNIT 	K L M WCS O P
	<ul style="list-style-type: none"> • B2622: INSIDE ANTENNA • B2623: INSIDE ANTENNA 	

* : With electronic steering column lock

BCM (BODY CONTROL MODULE)

< ECU DIAGNOSIS >

DTC Index

INFOID:000000005511907

NOTE:

- Details of time display
- CRNT: Displays when there is a malfunction now or after returning to the normal condition until turning ignition switch OFF → ON again.
- 1 - 39: Displayed if any previous malfunction is present when current condition is normal. It increases 1 → 2 → 3...38 → 39 after returning to the normal condition whenever ignition switch OFF → ON. The counter remains at 39 even if the number of cycles exceeds it. It is counted from 1 again when turning ignition switch OFF → ON after returning to the normal condition if the malfunction is detected again.

CONSULT display	Fail-safe	Intelligent Key warning lamp ON	Tire pressure monitor warning lamp ON	Reference page
No DTC is detected. further testing may be required.	—	—	—	—
U1000: CAN COMM CIRCUIT	—	—	—	BCS-36
U1010: CONTROL UNIT (CAN)	—	—	—	BCS-37
U0415: VEHICLE SPEED SIG	—	—	—	BCS-38
B2013: ID DISCORD BCM-S/L*	×	—	—	SEC-39
B2014: CHAIN OF S/L-BCM*	×	—	—	SEC-40
B2190: NATS ANTENNA AMP	×	—	—	SEC-43
B2191: DIFFERENCE OF KEY	×	—	—	SEC-46
B2192: ID DISCORD BCM-ECM	×	—	—	SEC-47
B2193: CHAIN OF BCM-ECM	×	—	—	SEC-48
B2553: IGNITION RELAY	—	—	—	PCS-55
B2555: STOP LAMP	—	—	—	SEC-49
B2556: PUSH-BTN IGN SW	—	×	—	SEC-52
B2557: VEHICLE SPEED	×	×	—	SEC-54
B2560: STARTER CONT RELAY	×	×	—	SEC-55
B2562: LOW VOLTAGE	—	—	—	BCS-39
B2601: SHIFT POSITION	×	×	—	SEC-56
B2602: SHIFT POSITION	×	×	—	SEC-59
B2603: SHIFT POSI STATUS	×	×	—	SEC-62
B2604: TRANSMISSION RANGE SWITCH	×	×	—	SEC-65
B2605: TRANSMISSION RANGE SWITCH	×	×	—	SEC-67
B2606: S/L RELAY*	×	×	—	SEC-69
B2607: S/L RELAY*	×	×	—	SEC-70
B2608: STARTER RELAY	×	×	—	SEC-72
B2609: S/L STATUS*	×	×	—	SEC-74
B260A: IGNITION RELAY	×	×	—	PCS-57
B260B: STEERING LOCK UNIT*	—	×	—	SEC-78
B260C: STEERING LOCK UNIT*	—	×	—	SEC-79
B260D: STEERING LOCK UNIT*	—	×	—	SEC-80
B260F: ENG STATE SIG LOST	×	×	—	SEC-81
B2612: S/L STATUS*	×	×	—	SEC-83
B2614: ACC RELAY CIRC	—	×	—	PCS-59

BCM (BODY CONTROL MODULE)

< ECU DIAGNOSIS >

CONSULT display	Fail-safe	Intelligent Key warning lamp ON	Tire pressure monitor warning lamp ON	Reference page	
B2615: BLOWER RELAY CIRC	—	×	—	PCS-62	A
B2616: IGN RELAY CIRC	—	×	—	PCS-65	B
B2617: STARTER RELAY CIRC	×	×	—	PCS-65	
B2618: BCM	×	×	—	PCS-68	C
B2619: BCM*	×	×	—	SEC-89	
B261A: PUSH-BTN IGN SW	—	×	—	SEC-90	
B2622: INSIDE ANTENNA	—	—	—	DLK-60	D
B2623: INSIDE ANTENNA	—	—	—	DLK-63	
B26E1: ENG STATE NO RES	×	×	—	SEC-82	E
C1704: LOW PRESSURE FL	—	—	×	WT-48	
C1705: LOW PRESSURE FR	—	—	×	WT-48	
C1706: LOW PRESSURE RR	—	—	×	WT-48	F
C1707: LOW PRESSURE RL	—	—	×	WT-48	
C1708: [NO DATA] FL	—	—	×	WT-14	G
C1709: [NO DATA] FR	—	—	×	WT-14	
C1710: [NO DATA] RR	—	—	×	WT-14	
C1711: [NO DATA] RL	—	—	×	WT-14	H
C1712: [CHECKSUM ERR] FL	—	—	×	WT-16	
C1713: [CHECKSUM ERR] FR	—	—	×	WT-16	I
C1714: [CHECKSUM ERR] RR	—	—	×	WT-16	
C1715: [CHECKSUM ERR] RL	—	—	×	WT-16	
C1716: [PRESSDATA ERR] FL	—	—	×	WT-18	J
C1717: [PRESSDATA ERR] FR	—	—	×	WT-18	
C1718: [PRESSDATA ERR] RR	—	—	×	WT-18	K
C1719: [PRESSDATA ERR] RL	—	—	×	WT-18	
C1720: [CODE ERR] FL	—	—	×	WT-16	
C1721: [CODE ERR] FR	—	—	×	WT-16	L
C1722: [CODE ERR] RR	—	—	×	WT-16	
C1723: [CODE ERR] RL	—	—	×	WT-16	
C1724: [BATT VOLT LOW] FL	—	—	×	WT-16	M
C1725: [BATT VOLT LOW] FR	—	—	×	WT-16	
C1726: [BATT VOLT LOW] RR	—	—	×	WT-16	WCS
C1727: [BATT VOLT LOW] RL	—	—	×	WT-16	
C1729: VHCL SPEED SIG ERR	—	—	×	WT-20	
C1734: CONTROL UNIT	—	—	×	WT-21	O

* : With electronic steering column lock

THE PARKING BRAKE RELEASE WARNING CONTINUES SOUNDING, OR DOES NOT SOUND

< SYMPTOM DIAGNOSIS >

SYMPTOM DIAGNOSIS

THE PARKING BRAKE RELEASE WARNING CONTINUES SOUNDING, OR DOES NOT SOUND

Description

INFOID:000000005459976

- The parking brake warning buzzer sounds continuously during vehicle travel though the parking brake is released
- The parking brake warning buzzer does not sound at all even though driving the vehicle with the parking brake applied.

Diagnosis Procedure

INFOID:000000005459977

1. CHECK PARKING BRAKE WARNING LAMP

1. Start the engine.
2. Check the operation of the brake warning lamp by operating the parking brake.

Parking brake ON : ON
Parking brake OFF : OFF

Is the inspection result normal?

- YES >> Replace the combination meter. Refer to [MWI-140, "Removal and Installation"](#).
NO >> GO TO 2

2. CHECK PARKING BRAKE SWITCH SIGNAL CIRCUIT

Perform inspection of the parking brake switch signal circuit. Refer to [MWI-43, "Diagnosis Procedure"](#).

Is the inspection result normal?

- YES >> GO TO 3
NO >> Repair or replace harness.

3. CHECK PARKING BRAKE SWITCH UNIT

Perform a unit inspection for the parking brake switch. Refer to [MWI-43, "Component Inspection"](#).

Is the inspection result normal?

- YES >> Replace the combination meter. Refer to [MWI-140, "Removal and Installation"](#).
NO >> Replace the parking brake switch.

THE LIGHT REMINDER WARNING DOES NOT SOUND

< SYMPTOM DIAGNOSIS >

THE LIGHT REMINDER WARNING DOES NOT SOUND

Description

INFOID:000000005459978

Light reminder warning does not sound even though headlamp is illuminated.

Diagnosis Procedure

INFOID:000000005459979

1. CHECK COMBINATION SWITCH (LIGHT SWITCH) OPERATION

Check that the headlamps operate normally by operating the combination switch (light switch).

Do they operate normally?

YES >> GO TO 2

NO >> Refer to [EXL-6, "Work Flow"](#).

2. CHECK DOOR SWITCH LH SIGNAL CIRCUIT

Perform inspection of the door switch LH signal circuit. Refer to [WCS-19, "Diagnosis Procedure"](#).

Is the inspection result normal?

YES >> GO TO 3

NO >> Repair or replace harness.

3. CHECK DOOR SWITCH LH

Perform a unit inspection for the door switch LH. Refer to [WCS-19, "Component Function Check"](#).

Is the inspection result normal?

YES >> Replace the BCM. Refer to [BCS-87, "Removal and Installation"](#).

NO >> Replace the front door switch LH.

A
B
C
D
E
F
G
H
I
J
K
L
M
O
P

WCS

THE SEAT BELT WARNING CONTINUES SOUNDING, OR DOES NOT SOUND

< SYMPTOM DIAGNOSIS >

THE SEAT BELT WARNING CONTINUES SOUNDING, OR DOES NOT SOUND

Description

INFOID:000000005459980

- Seat belt warning does not sound even though driver seat belt is not fastened.
- Seat belt warning sounds even though driver seat belt is fastened.

Diagnosis Procedure

INFOID:000000005459981

1. CHECK WARNING CHIME OPERATION

With the driver door open, turn lighting switch to 1st or 2nd position.

Does warning chime sound?

YES >> GO TO 2

NO >> Replace combination meter. Refer to [MWI-140, "Removal and Installation"](#).

2. CHECK SEAT BELT WARNING LAMP

1. Turn ignition switch ON.
2. Check the operation of the seat belt warning lamp in the combination meter.

Seat belt fastened : OFF

Seat belt not fastened : ON

Is the inspection result normal?

YES >> Replace BCM. Refer to [BCS-87, "Removal and Installation"](#).

NO >> GO TO 3

3. CHECK SEAT BELT BUCKLE SWITCH CIRCUIT

Perform inspection of the seat belt buckle switch circuit. Refer to [WCS-20, "Diagnosis Procedure"](#).

Is the inspection result normal?

YES >> GO TO 4

NO >> Repair or replace harness.

4. CHECK SEAT BELT BUCKLE SWITCH UNIT

Perform a unit inspection for the seat belt buckle switch. Refer to [WCS-21, "Component Inspection"](#).

Is the inspection result normal?

YES >> Replace the combination meter. Refer to [MWI-140, "Removal and Installation"](#).

NO >> Replace the seat belt buckle switch LH.

PRECAUTIONS

< PRECAUTION >

PRECAUTION

PRECAUTIONS

Precaution for Supplemental Restraint System (SRS) "AIR BAG" and "SEAT BELT PRE-TENSIONER"

INFOID:000000005485401

The Supplemental Restraint System such as "AIR BAG" and "SEAT BELT PRE-TENSIONER", used along with a front seat belt, helps to reduce the risk or severity of injury to the driver and front passenger for certain types of collision. This system includes seat belt switch inputs and dual stage front air bag modules. The SRS system uses the seat belt switches to determine the front air bag deployment, and may only deploy one front air bag, depending on the severity of a collision and whether the front occupants are belted or unbelted. Information necessary to service the system safely is included in the SR and SB section of this Service Manual.

WARNING:

- To avoid rendering the SRS inoperative, which could increase the risk of personal injury or death in the event of a collision which would result in air bag inflation, all maintenance must be performed by an authorized NISSAN/INFINITI dealer.
- Improper maintenance, including incorrect removal and installation of the SRS, can lead to personal injury caused by unintentional activation of the system. For removal of Spiral Cable and Air Bag Module, see the SR section.
- Do not use electrical test equipment on any circuit related to the SRS unless instructed to in this Service Manual. SRS wiring harnesses can be identified by yellow and/or orange harnesses or harness connectors.

PRECAUTIONS WHEN USING POWER TOOLS (AIR OR ELECTRIC) AND HAMMERS

WARNING:

- When working near the Airbag Diagnosis Sensor Unit or other Airbag System sensors with the Ignition ON or engine running, DO NOT use air or electric power tools or strike near the sensor(s) with a hammer. Heavy vibration could activate the sensor(s) and deploy the air bag(s), possibly causing serious injury.
- When using air or electric power tools or hammers, always switch the Ignition OFF, disconnect the battery, and wait at least 3 minutes before performing any service.

Precautions Necessary for Steering Wheel Rotation after Battery Disconnect (Early Production, With Electronic Steering Column Lock)

INFOID:000000005485402

NOTE:

- Before removing and installing any control units, first turn the push-button ignition switch to the LOCK position, then disconnect both battery cables.
- After finishing work, confirm that all control unit connectors are connected properly, then re-connect both battery cables.
- Always use CONSULT-III to perform self-diagnosis as a part of each function inspection after finishing work. If a DTC is detected, perform trouble diagnosis according to self-diagnosis results.

This vehicle is equipped with a push-button ignition switch and a steering lock unit.

If the battery is disconnected or discharged, the steering wheel will lock and cannot be turned.

If turning the steering wheel is required with the battery disconnected or discharged, follow the procedure below before starting the repair operation.

OPERATION PROCEDURE

1. Connect both battery cables.

NOTE:

Supply power using jumper cables if battery is discharged.

2. Carry the Intelligent Key or insert it to the key slot and turn the push-button ignition switch to ACC position. (At this time, the steering lock will be released.)
3. Disconnect both battery cables. The steering lock will remain released with both battery cables disconnected and the steering wheel can be turned.
4. Perform the necessary repair operation.

A
B
C
D
E
F
G
H
I
J
K
L
M
WCS
O
P

PRECAUTIONS

< PRECAUTION >

5. When the repair work is completed, re-connect both battery cables. With the brake pedal released, turn the push-button ignition switch from ACC position to ON position, then to LOCK position. (The steering wheel will lock when the push-button ignition switch is turned to LOCK position.)
6. Perform self-diagnosis check of all control units using CONSULT-III.